

ITA/ENG

MACCHINE CURVATUBI SENZA ANIMA ROTARY DRAW BENDERS

CATALOGO GENERALE/GENERAL CATALOGUE



MADE IN ITALY



CML
INTERNATIONAL
SpA

ATTENZIONE

Quanto illustrato in questo catalogo è di proprietà di CML International SpA e a termini di legge ne è vietata la riproduzione anche parziale, se non esplicitamente autorizzata.

I prodotti di CML International SpA, sono coperti da Brevetti.

TUTTE LE IMMAGINI

sono inserite a scopo illustrativo e non costituiscono elemento contrattuale.

Tutti i prodotti del catalogo, possono subire variazioni o modifiche senza obbligo di preavviso.

**BREVETTO ERCOLINA**

I prodotti riportanti questo logo sono protetti da brevetto di proprietà intellettuale Ercolina Nazionale e o Esteri.

ATTENTION

What is shown in this catalog is property of CML International SpA and according to the law the reproduction is prohibited, unless explicitly authorized.

The products of CML International SpA are covered by patents.

ALL IMAGES

are inserted only for illustrative purposes and do not constitute a contractual element.

All products in the catalog may undergo variations or modifications without obligation of notice.

**PATENTED ERCOLINA**

The products bearing this logo are protected by Ercolina National and Esters intellectual property patent.



L'AZIENDA

Nell'ottobre del 1973 la Costruzioni Meccaniche Liri (CML) sviluppa e brevetta macchine curvatubi portatili, gli attuali modelli Jolly e Junior, e ne avvia la commercializzazione in tutto il mondo con il marchio ERCOLINA®, che grazie alla continua innovazione ed ai numerosi brevetti internazionali, si è andato affermando globalmente come sinonimo di qualità, affidabilità e durabilità. Tutte le macchine ERCOLINA® sono progettate, sviluppate e prodotte in Italia nell'unico stabilimento produttivo della CML International SpA, sito in Piedimonte San Germano (FR), località tra Roma e Napoli. L'azienda, vero e proprio centro di eccellenza tecnologico specializzato nella lavorazione del metallo, vanta oltre 100 dipendenti, una superficie coperta di oltre 16.000 mq ed un'attrezzata sala demo.

Un'esperienza ultra quarantennale, qualificate risorse umane, moderne infrastrutture, continui investimenti in ricerca & sviluppo e l'elevata qualità delle materie prime utilizzate permettono oggi alla CML International SpA di offrire al mercato una completa e moderna linea di macchine per la deformazione a freddo di tubi e profilati: curvatubi e curvaprofilati senza anima e con anima manuali, curvatrici a tre rulli, presse orizzontali, flangiatrici e sgolatubi semiautomatiche e completamente automatiche (NC & CNC) oltre 13 assi.

Le macchine ERCOLINA® sono commercializzate in tutto il mondo grazie ad un'ampia rete di distribuzione costituita da 4 filiali (in USA, Germania, Corea del Sud e Russia) e da rivenditori autorizzati (circa 600 in Italia e 200 nel mondo), tutti qualificati ed in grado di offrire servizi di pre e post vendita in linea con gli alti standard qualitativi ERCOLINA®. L'impegno, la professionalità e la passione muovono ancora oggi, come oltre quaranta anni fa, la CML International SpA verso la sua missione: la piena soddisfazione del cliente, nell'assoluto rispetto della qualità e competitività del prodotto. Inoltre, l'azienda è certificata ISO 9001:2008 ed è presente sul mercato nazionale e internazionale attraverso fiere, open house e dimostrazioni, che contribuiscono a garantire un contatto costante e personalizzato con il cliente. ERCOLINA® continua ad essere leader nel settore delle macchine curvatubi e curvaprofilati e nella lavorazione dei metalli; per saperne di più, visita il nostro sito www.ercolina.com

THE COMPANY

Founded in 1973, CML International S.p.A. began as an Italian manufacturer of small push-type benders, nowadays known around the world as Jolly and Junior. Due to a strong international patent, ERCOLINA® Trademark has rapidly established itself as a leading brand in major worldwide markets. Later, ERCOLINA® launched other machines including Ring Rollers, Horizontal Presses, Notchers, and others, which are completely designed and manufactured in Italy by CML. With a solid experience and a new infrastructure, CML improved its bending technology, offering mandrel benders with automatic working cycles and high precision CNC controls. Key aspects of the Company success are: continuous investments in research & development (more than 7% of profits), first-class quality of raw materials and a specialized workforce (more than 150 employees), wide distribution network (more than 60 retailers in Italy, 200 distributors throughout the world, 4 branches in Germany, USA, Korea and Russia).

Today the manufacturing plant, situated a between Rome and Naples and covering a surface of more than 16,000 m² is a state of the art technological center of specialized metalworking machinery. Commitment, expertise and dedication moves CML towards its mission, full customer satisfaction, with total abidance to quality (company certified UNI EN ISO 9001:2008).

CML International S.p.A. in Piedimonte San Germano (FR) Italy is the official and sole production plant for ERCOLINA®.

As an organization, CML International S.p.A. takes pride in having friendly, knowledgeable sales and customer service staff ready to assist your project needs. Our network of knowledgeable dealers in the metal fabricating industry offers local sales and support. **Our goal is to provide high quality machines at reasonable pricing with profitable solutions for your bending and fabricating needs. Our Mission is to develop successful long term relationships with our dealers and product owners.** Constantly seeking to innovate and improve our product offerings, customer service and business methods. Continue to lead the market with product innovation, and sales of tube and pipe bending machinery. Develop beneficial Ercolina product information and support on the World Wide Web including e-commerce. Develop and expand new markets for our products.





CML INTERNATIONAL
FUTURE IS NOW

SINCE 1973



6	MACCHINE SENZA ANIMA - ROTARY DRAW BENDERS
7	NUOVE INNOVAZIONI ERCOLINA - NEW ERCOLINA INNOVATION
8	CONTROLLO EDT PLUS - EDT PLUS CONTROL
9	NUOVO CONTROLLO TC PLUS - NEW TC PLUS CONTROL
10	TABELLE CAPACITA' - CAPACITY TABLE
12	TB180PT
14	TB130PT
16	TB100PT
18	TB80PT
20	MG030
22	MG030 EDT PLUS
24	TB60
26	TB60 EDT PLUS
28	TB050
30	TB050 EDT PLUS
32	HB60
34	SB48
36	SB48 EDT PLUS
38	MB42
40	MB42 EDT PLUS
42	MD070
44	MD083
46	MN092
48	ACCESSORIES - MEGABENDER - TOP BENDER - SUPER BENDER
52	ACCESSORIES - MEDIBENDER - MINIBENDER
58	UTENSILI MACCHINE SENZA ANIMA
59	NON MANDREL TOOLING
60	MATRICI PER MG030,TB60,TB050,SB48 (per spessori massimi di 4 mm)
61	FORMERS FOR MG030,TB60,TB050,SB48, (for max wall thickness 4 mm)
62	MATRICI PER MD070,MD083,MN092, MB42
63	FORMERS FOR MD070,MD083,MN092, MB42
64	MATRICI PER MD070,MD083,MN092, MB42
64	FORMERS FOR MD070,MD083,MN092, MB42
65	UTENSILI MACCHINE SENZA ANIMA
65	NON MANDREL TOOLING
67	MATRICI - FORMERS
85	UTENSILI MACCHINE SENZA ANIMA
85	NON MANDREL TOOLING
94	TABELLA DI CONVERSIONE - CONVERSION TABLE
96	CALCOLO SVILUPPO DELLA CURVA
98	CALCULATION OF THE BEND LENGTH

ITA

Le macchine curvatubi e curvaprofilati rappresentano l'eccellenza dell'Innovazione Ercolina, proprietaria di un sistema di curvatura senza anima che le ha permesso di posizionarsi da oltre 40 anni come leader mondiale nel settore della curvatura.

Le curvatubi senza anima sono ideali per tutti coloro interessati ad una macchina robusta ed affidabile che realizzi lavorazioni ad elevati standard qualitativi, facile da maneggiare e con budget contenuto

I prodotti Ercolina della linea SenzaAnima offrono ulteriori punti di forza quali:

- Rapida sostituzione degli utensili
- Bassa manutenzione
- Facilmente trasportabili grazie a ruote e pratiche maniglie retrattili a scomparsa nel corpo macchina
- Lunga durata anche in condizioni di lavoro estreme

Materiali di primissima qualità compongono il corpo macchina; schede elettroniche e componenti elettrici utilizzano accorti sistemi di sicurezza per evitare sovraccarichi lesivi dell'integrità del prodotto; la sicurezza dell'operatore è sempre garantita da pulsanti di stop d'emergenza.

-Una gamma completa di accessori e utensili rende possibile la personalizzazione di tutti i modelli. L'utilizzo di attrezzature speciali permette di curvare i profili più disparati nei diversi settori di applicazione: serramentistica, idraulica, arredamento, cantieristica navale, carpenteria, automotive, e molti altri ancora.

Le matrici Ercolina, sono la parte principale che correda le macchine, per le quali si sono adottate forti azioni costruttive e di investimento atte a salvaguardare la comprovata tecnologia meccanica brevettata.

Particolare attenzione è stata riservata al design della matrice, costituita da un unico blocco metallico senza parti collegate o aggiunte. Il particolare profilo delle gole, perfezionato in oltre 40 anni di lavoro, permette di ottenere curve di ottima qualità anche con tubi di basso spessore e con materiali molto morbidi. A garanzia della precisione di curvatura, è installato un encoder di misurazione dell'angolo di rotazione che assicura una accuratezza spinta al singolo grado.

I prodotti Ercolina della famiglia senza anima offrono la possibilità di visualizzare e programmare l'angolo di curva desiderato. Al contempo è sempre possibile programmare il cosiddetto angolo di recupero, parametro elastico intrinseco di ciascun materiale per facilitare le operazioni di curvatura. I pannelli di controllo delle macchine Ercolina sono studiati per rendere la programmazione dei cicli di lavoro molto intuitiva. Le funzioni operative sono facilmente impostabili, tutti i menu di controllo sono multi lingua per una assoluta semplicità di utilizzo. Gli utilizzatori delle macchine senz'anima necessitano una fase di apprendimento del prodotto Ercolina molto breve. Precisione e manualità dell'utilizzatore rendono possibili lavorazioni pensabili solo con prodotti molto sofisticati.



ENG

Non Mandrel Machines represent the top of the range in Ercolina® Innovation, owner of a patented non mandrel bending system that has allowed Ercolina® to be for 40 and more years the leading product in the bending market.

Ercolina® Non Mandrel machines are the best solution for everyone who is looking for heavy structure machinery with high quality bend standards, but easy to handle and with limited budget.

Ercolina® formers are the most important machine equipment, which has undergone many design improvements that confirm the Ercolina® patented technology. Besides being produced as a single metal block with no other welded pieces, Ercolina® formers present a particular groove shape, enhanced in 30 years of constant designing to achieve superior quality bends also with small wall thickness tubes and very soft materials. Furthermore, an encoder for measuring former rotation angle is installed to assure bend accuracy up to 1° bend angle.

Ercolina® control panels are designed for user friendly bend programming. Operating functions are easy to set, all control menu are multi-languages. A brief product training is required for operating Ercolina® non mandrel machines. Accuracy and simple operator skills make these machines the optimal choice compared to other very expensive and sophisticated machinery.

With Ercolina® non mandrel machines the operator can program and control the required bend angle, as well as the springback angle, a material elasticity parameter to eliminate material springback effects.

Ercolina® non mandrel range grants other very competitive strengths such as:

Quick tool change over;

- Very low maintenance. Completely electric machines with no hydraulic components;
- Machines designed to be easily moved with solid base wheels and lifting handles;
- Long-lasting products designed to perform under the hardest and challenging conditions.
- All machines are made of finest quality materials. Electronic boards and all electric parts use advanced safety systems for reliable overload protection;

Operator safety measures. All machines are supplied with emergency stop buttons. Ercolina® products comply with CE Standards;

Bending thin and heavy-duty profiles in few seconds and with remarkable result

Customized products guaranteed by a 40-year-old technical department constantly dedicated to special tooling applications. Ercolina® special tooling allows to bend all kind of profiles in all different application sectors: ironworking, furniture, aircraft engineering, automotive, shipyard, motorcycling, plumbing, hydraulic, piping industry, etc.

Ercolina® grants a long experience with Non Mandrel Benders in manufacturing and selling bending tools in every country of the world.





MATRICE CON ROTAZIONE DX E SX

BREVETTO ERCOLINA

ITA

Questa matrice (Brevetto Ercolina) montato sulla linea macchine senz'anima e settato dal nuovo controllo TCPlus, permette di fare curve a destra e/o sinistra in modo alternato e continuo, senza cambiare utensile, senza acquistare una seconda macchina.

L'utensile brevettato comprende:

- * Matrice DX e SX
- * Contromatrice DX e SX
- * Antigrinza anteriore e posteriore

Fino ad oggi le macchine Ercolina ci hanno abituato a curvare in senso anti orario, con questo nuovo brevetto, si aprono nuovi orizzonti di produzione, con la curva in entrambi i sensi ed un solo utensile, il nuovo brevetto Ercolina comporta enormi vantaggi in termini di costi, tempi di realizzazione di prodotto e riproducibilità.

Grazie al nuovo controllo TCPlus e a questa nuova Matrice DX e SX è possibile infatti produrre grandi quantità di pezzi in serie, senza alcuna discrepanza tra loro.

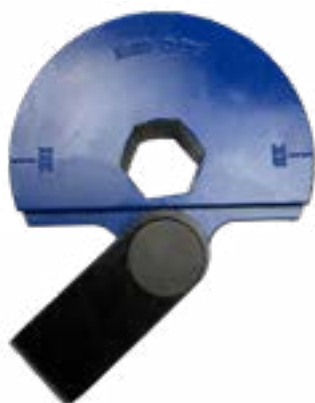

FORMER L/R BENDING

PATENTED ERCOLINA

ENG

This former (Ercolina Patent) mounted on the non mandrel machines set by the new TCPlus control, allows you to make right and / or left bend alternately and continuously, without changing tools, without buying a second machine.

The patented tool includes:

- * Left and Right former
- * Left and Right counterbending die
- * Front and rear wiper die

Until today the Ercolina machines bent in an anti-clockwise direction, with this new patent, new production horizons open up, bending in both directions and only one tool, the new Ercolina patent involves huge advantages in terms of costs, times with of product realization and repeatability.

Thanks to the new TCPlus control and this new Left and Right former, it is possible to produce large quantities of pieces in series, without any difference between them.

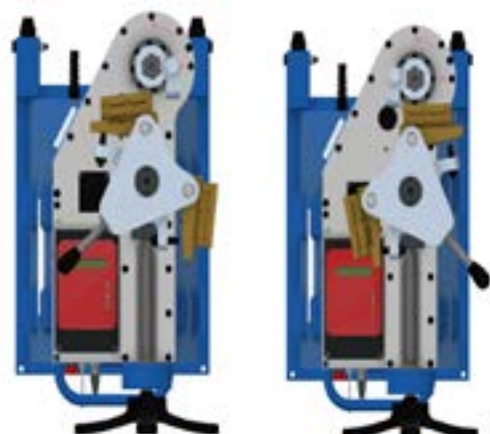

MATRICE CON ROTAZIONE DX E SX
FORMER L/R BENDING

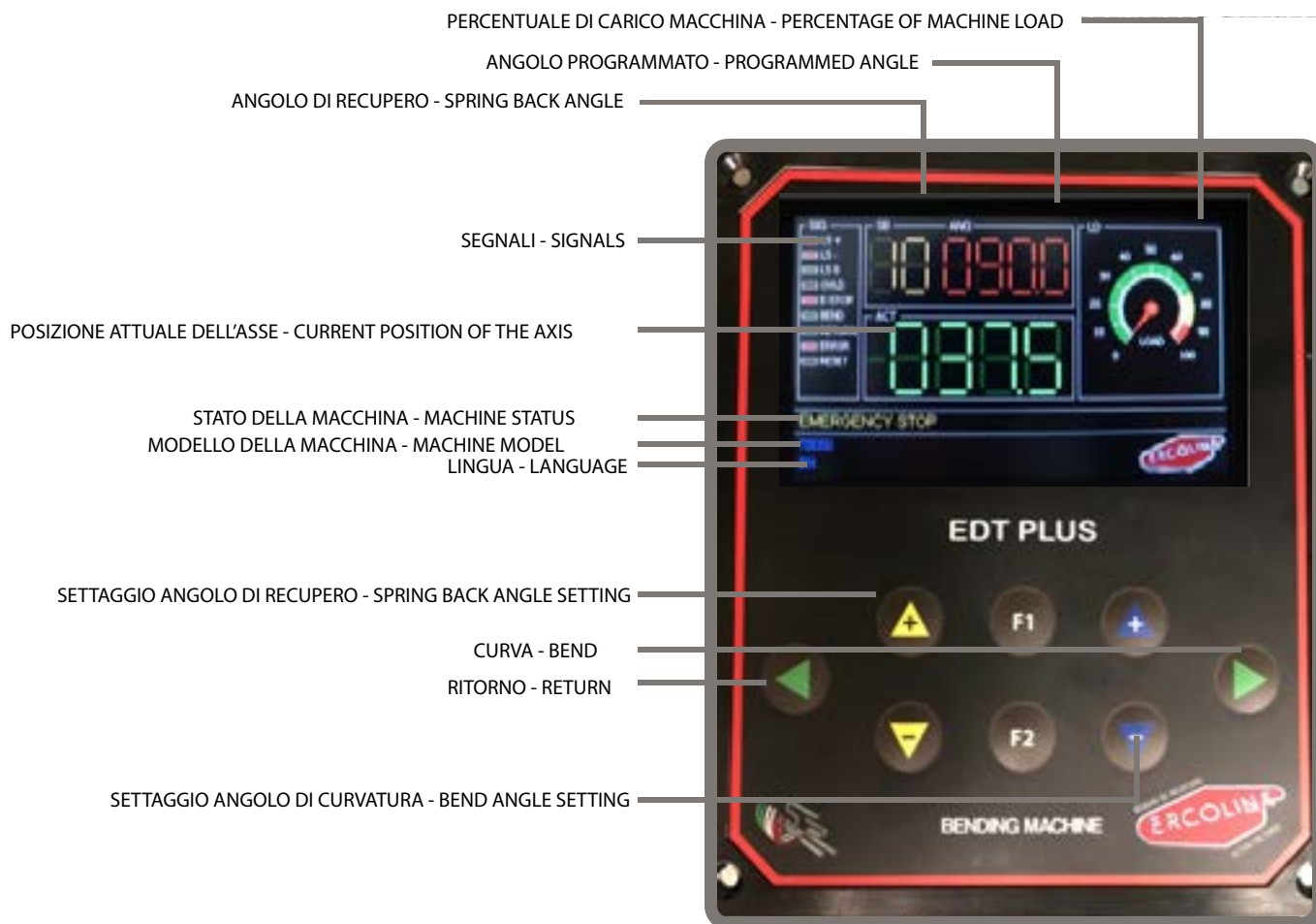

- Facile da programmare, per un'ottima qualità di curvatura;
- Controllo facile ed intuitivo;
- Display da 4,3"
- Multilingua;
- Programmazione angolo di curvatura, inserimento del valore della compensazione ritorno elastico;
- Visualizzazione della percentuale di carico in fase di curvatura;

-
- Easy to program, for excellent bending quality;
 - Easy and intuitive control;
 - 4,3" display;
 - Multilingual;
 - Angle and spring back programming;
 - Display of machine load during bending;



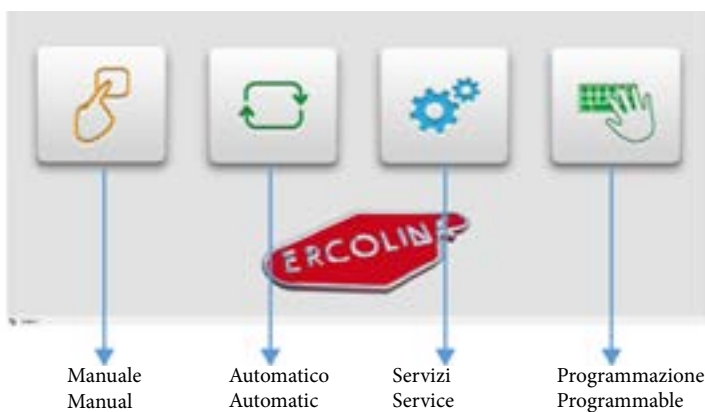
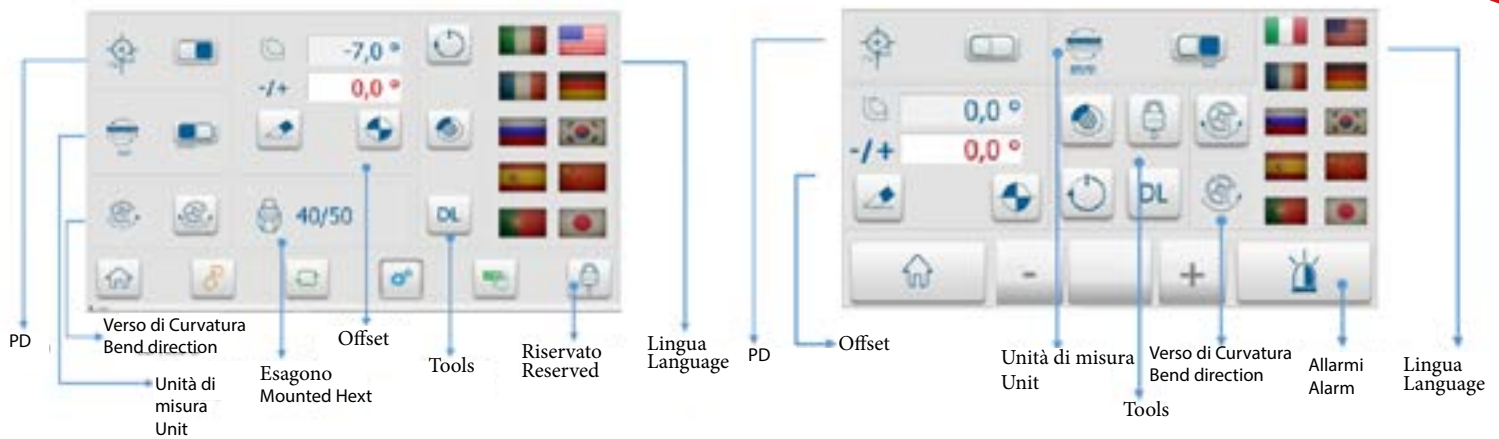

4,3"

7"



MB42



TB80



SB48



TB100



TB050



TB130



TB060

























TB180



MG030























- Meno contenuti testuali ed icone rinnovate per un utilizzo più veloce e facile
- Possibilità di lavoro in diverse modalità: automatic, MDI manuale, programmazione
- Funzione avanzata di OFFSET
- Database utensili secondo il programma utilizzato
- Cambio lingua immediato
- Auto-tuning dei principali componenti macchina (solo sul 7")
- Funzione rapida di cambio unità di misura (mm-pollici)
- Velocità di curvatura programmabile per ogni singola curva del programma
- Possibilità di programmi illimitati su Porta USB (opzionale)
- Ogni singolo programma può contenere fino a 30 curve
- Più sicurezza ed assistenza al cliente più efficiente grazie alla connessione LAN/wi-fi (opzionale)
- che permette di risolvere problemi tecnici, aggiornare la macchina e monitorare i processi da remoto

- Less text and improved new icons for a faster and ease of use
- The operator can works in several ways: automatic mode, MDI manual mode, programming mode
- Advanced OFFSET function
- Tool's store function by program
- Easy language changing
- Auto-tuning of the main machine components (only 7")
- Fast inches-mm switching function
- Programmable bending speed for each single bend of the program
- Unlimited programs possibility (USB port)
- Every program can contain up to 30 different bends and spring back.
- Efficient security and customer assistance thanks to the LAN and/or WI-FI connection (upon request) that allows to solve technical issues, to make updates and to monitor the process by remote.

SEZ.	MATERIALE - MATERIAL	MEDI BENDER			MINI BENDER	MEGA BENDER
		MB42	MD070	MD083	MN092	MG030
		4 cm ³	1.9 cm ³	1.9 cm ³	0.7 cm ³	15 cm ³
		MAX Ø X SPESS. (mm) Max Ø x Wall thickness (mm)				
	Tubo AnsiB36, 10 e API - Gas Tube	1" 1/4 x 3,56	1" x 3,38	1" x 3,38	3/4" x 2,87	2"x5,54
	Tubo standard acciaio - Standard Steel Tube	42x3	38x1,5	38x1,5	27x2,3	76x3
	Tubo Mobilio - Forniture tube	48x1,5	38x1,5	38x1,5	28x2,5	76x3
	Acciaio ST35 (per oleod.) - Hydraulic Steel ST35	42x4	35x3	35x3	28x1,5	50x10
	Inox AISI 304-318 - Stainless Steel AISI 304-318	42x2	30x2	30x2	28x1,5	70x4
	Inox AISI 308 (per alim.) - Stainless Steel AISI 308	42x2	35x1,5	35x1,5	28x1,5	76x1,6
	Ottone ricotto - Soft Brass	50x3	42x1,5	42x1,5	28x2	76x4
	Alluminio curvabile - Hard Copper & Aluminium	54x2	42x1,5	42x1,5	28x1,5	76x6
	Rame ricotto - Soft Copper	54x2	50x2	50x2	35x1,3	76x6
	Tubo Conduit (TAZ) - Conduit Tube (TAZ)	60x2	50x2	50x2	42x2	76,3x3,25
	Mepla, Geberit e simili - Mepla, Geberit and similars	50x4	50x4	50x4	50x4	50x4
	Acciaio FE42 (EN: S275J0) - Mild Steel (EN: S275J0)	30	20	20	16	45
	Acciaio FE42 (EN:S275J0) - Mild Steel (EN: S275J0)	7x42	10x25	10x25	/	10x90
	Acciaio FE42 (EN:S275J0) - Mild Steel (EN: S275J0)	40x12	25x16	25x16	/	75x15
	Acciaio FE42 (EN:S275J0) - Mild Steel (EN: S275J0)	40 x 20	25x20	25x20	/	75x30
	Acciaio FE42 (EN:S275J0) - Mild Steel (EN: S275J0)	40x20x2,6	/	/	/	70x40x4
	Acciaio FE42 (EN:S275J0) - Mild Steel (EN: S275J0)	40x20x2,6	/	/	/	70x40x8
	Acciaio FE42:(EN:S275J0) - Mild Steel (EN: S275J0)	18x35 x 2	15x25 x 3	15x25 x 3	/	30x60 x 3
	Acciaio FE42 (EN:S275J0) - Mild Steel (EN: S275J0)	35x35 x 3	25x25 x 3	25x25 x 3	/	60x60 x 3
	Acciaio FE42 (EN:S275J0) - Mild Steel (EN: S275J0)	25x25	20x20	20x20	/	40x40
	Acciaio FE42 (EN:S275J0) - Mild Steel (EN: S275J0)	35x35 x 5	30x30 x 5	30x30 x 5	/	60x60 x 6
	Acciaio FE42 (EN:S275J0) - Mild Steel (EN: S275J0)	28x14 x 5	30x15 x 5	30x15 x 5	/	50x20 x 6

*Le capacità si riferiscono a materiali con resistenza di 42 Kg/mm - L.E. 250 N/mm 2

*Capacities based on materials with T.S. 42 Kg/mm (P.S.I. 60.000) - Y.P. 25 Kg/mm 2 (P.S.I. 36.000)

SEZ.	MATERIALE - MATERIAL	TOP BENDER							SUPER BENDER
		TB180	TB130	TB100	TB80	TB60	HB60	TB50/EDT	SB48
		180 cm ³	80 cm ³	43 cm ³	20 cm ³	10 cm ³	10 cm ³	10.5 cm ³	6 cm ³
		MAX Ø X SPESS. (mm) Max Ø x Wall thickness (mm)							
	Tubo AnsiB36, 10 e API - Gas Tube	6" x7,11	4" x8,56	3"1/2 x4	2"1/2x5.16	2" x3,91	2" x3,91	2" x3,91	1"1/2 x3.68
	Tubo standard acciaio - Standard Steel Tube	150x7,1	127x7,1	100x6	76.1x5.4	60x4	60,3x4,5	60x3	48x3,5
	Tubo Mobilio - Forniture tube	150x9	127x7,1	100x6	76x2	60x4	60x2	60x4	54x1,5
	Acciaio ST35 (per oleod.) - Hydraulic Steel ST35	50x10	50x10	50x10	50x10	50x10	50x10	50x10	50x4
	Inox AISI 304-318 - Stainless Steel AISI 304-318	141,3x6,55	114,3x5,6	100x3,6	76,1x3,2	60x2	60,3x2,6	60x2	48x2
	Inox AISI 308 (per alim.) - Stainless Steel AISI 308	141,3x6,55	114,3x5,6	100x3,6	76,1x3,2	60x3	60,3x2,6	60x2	48x2
	Ottone ricotto - Soft Brass	168,3x9	139,7x8,8	114,3x6,3	76,1x14,2	60x6	60,3x12,5	60x4	60x3
	Alluminio curvabile - Hard Copper & Aluminium	168,3x9	139,7x8,8	114,3x6,3	76,1x6,3	64x6	60,3x5,4	64x4	64x2
	Rame ricotto - Soft Copper	64x6	64x6	114,4x6,3	76,1x16	64x6	60,3x11	64x4	64x2
	Tubo Conduit (TAZ) - Conduit Tube (TAZ)	88,9x3,65	88,9x3,65	88,9x3,65	76,3x3,65	63x4	60,3x3,25	60x4	60x2
	Mepla, Geberit e simili - Mepla, Geberit and similars	50x4	50x4	100x5	75x9,7	50x4	63x43	50x4	50x4
	Acciaio FE42 (EN: S275J0) - Mild Steel (EN: S275J0)	110	90	70	55	35	45	35	32
	Acciaio FE42 (EN:S275J0) - Mild Steel (EN: S275J0)	120x60	100x50	80x40	75x20	14x60	60x30	10x60	8x48
	Acciaio FE42 (EN:S275J0) - Mild Steel (EN: S275J0)	150x45	130x25	100x25	75x20	60x20	60x16	60x16	45x16
	Acciaio FE42 (EN:S275J0) - Mild Steel (EN: S275J0)	200x60	130x60	100x50	75x30	60x35	60x30	60x30	45x25
	Acciaio FE42 (EN:S275J0) - Mild Steel (EN: S275J0)	160x60x11	120x40x10	100x50x6,3	70x40x6	60x30x6	60x30x4	60x30x4	50x25x3
	Acciaio FE42 (EN:S275J0) - Mild Steel (EN: S275J0)	160x80x12,5	120x50x11	100x60x9	70x50x6	60x40x7	60x40x7	60x40x5	50x30x5
	Acciaio FE42:(EN:S275J0) - Mild Steel (EN: S275J0)	140x70x12	120x60x9	100x60x4	70x50x5	25x50 x 3	60x40x3	25x50 x 3	20x40 x 3
	Acciaio FE42 (EN:S275J0) - Mild Steel (EN: S275J0)	140x140x6	90x90x10	90x90x4	74x75x3	50x50 x 3	55x55x2,5	50x50 x 3	40x40 x 3
	Acciaio FE42 (EN:S275J0) - Mild Steel (EN: S275J0)	90x90	75x75	60x60	45x45	30x30	35x35	30x30	30x30
	Acciaio FE42 (EN:S275J0) - Mild Steel (EN: S275J0)	120x120x10	100x100x10	90x90x6	70x70x9	50x50 x 6	60x60x8	50x50 x 6	40x40 x 5
	Acciaio FE42 (EN:S275J0) - Mild Steel (EN: S275J0)	120x120x8	100x100x8	90x90x6	65x42x5,5	40x20 x 6	40x35 x 5	40x20 x 6	32x16 x 5

*Le capacità si riferiscono a materiali con resistenza di 42 Kg/mm - L.E. 250 N/mm²

*Capacities based on materials with T.S. 42 Kg/mm (P.S.I. 60.000) - Y.P. 25 Kg/mm² (P.S.I. 36.000)



MODELLI DISPONIBILI

Articolo	Descrizione	Alimentazione
TB180PT	Topbender TB180	Trifase

MODELS AVAILABLE

Article	Description	Tension
TB180PT	Topbender TB180	Three phase

CARATTERISTICHE

- Con Controllo TCPlus
- Touch screen a colori 7"
- Icone rinnovate per un facile utilizzo
- Modalità: automatico, MDI manuale, programmazione
- Funzione avanzata di OFFSET
- Cambio lingua immediato
- Auto-tuning dei principali componenti macchina
- Funzione rapida di cambio unità di misura (mm-pollici)
- Velocità di curvatura programmabile per ogni singola curva del programma
- Possibilità di programmi illimitati su Porta USB (optional)
- Ogni singolo programma può contenere fino a 30 curve
- Possibilità di curvare a destra e sinistra
- Possibilità di aggiungere banco posizionatore

FEATURES

- New TCPlus control
- 7" colour touch screen
- Icons for ease use
- Automatic mode, MDI manual mode, programming mode
- Advanced OFFSET function
- Easy language change
- Auto-tuning of the main machine components
- Programmable bending speed for each single bend of the program
- Unlimited programs possibility on USB port (optional)
- Every program can contain up to 30 different bends
- Possibility to bend left and right
- Positioning Device (optional)

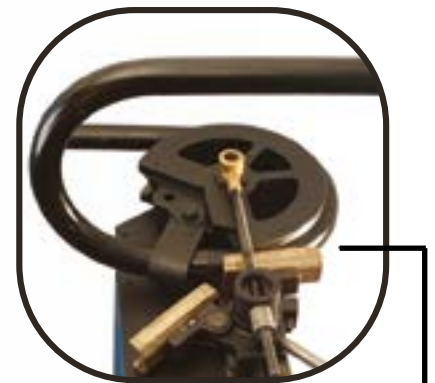

MATRICE CON ROTAZIONE DX E SX
FORMER L/R BENDING

DATI TECNICI / TECHNICAL DATA

Modulo di Flessione Flexion Modulus	180 cm ³
Min Diametro Esterno Min. outside diameter	10 mm 1/8" Gas
Raggio Max. di Curvatura (CLR) Max bending radius (CLR)	800 mm
Raggio Min. di Curvatura (CLR) Min bending radius (CLR)	100 mm*
Potenza Installata Motor	15 kW
Tensione di alimentazione Voltage requirement	400 V3PH/50-60 Hz
Velocità di curvatura Bending speed	1 rpm
Dimensioni Dimensions	1000 x 1475 x 1900 mm
Peso Weight	2700 Kg

* I raggi minori di 100 mm sono a richiesta.

* Radii less than 100 mm are on request.

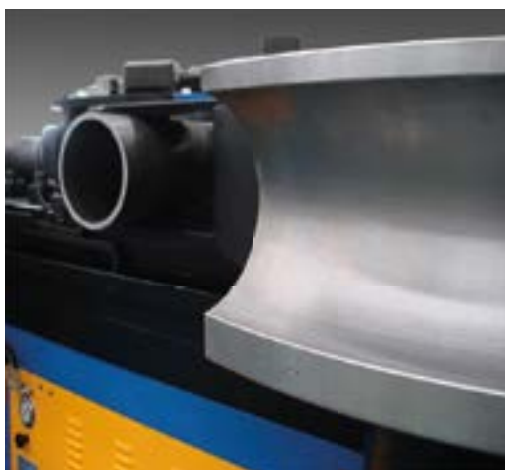
MAXIMUM CAPACITY - (mm)

SEZ.	MATERIALE - MATERIAL	180 cm ³
	Tubo AnsiB36, 10 e API - Gas Tube	6" x 7,11
	Tubo standard acciaio - Standard Steel Tube	150x7,1
	Inox - Stainless Steel	141,3x6,55
	Alluminio curvabile - Hard Copper & Aluminium	168,3x9
	Rame ricotto - Soft Copper	64x6
	Acciaio FE42 (EN: S275J0) - Mild Steel (EN: S275J0)	110
	Acciaio FE42 (EN:S275J0) - Mild Steel (EN: S275J0) (hardway)	150x45
	Acciaio FE42 (EN:S275J0) - Mild Steel (EN: S275J0) (easyway)	150x60
	Acciaio FE42 (EN:S275J0) - Mild Steel (EN: S275J0) (easyway)	160x80x12,5
	Acciaio FE42:(EN:S275J0) - Mild Steel (EN: S275J0) (hardway)	140x70x12
	Acciaio FE42 (EN:S275J0) - Mild Steel (EN: S275J0)	140x140x6
	Acciaio FE42 (EN:S275J0) - Mild Steel (EN: S275J0)	90x90
	Acciaio FE42 (EN:S275J0) - Mild Steel (EN: S275J0) (easyway)	120x120x10
	Acciaio FE42 (EN:S275J0) - Mild Steel (EN: S275J0) (easyway)	120x120x8

MODELLI DISPONIBILI

Articolo	Descrizione	Alimentazione
TB130PT	Topbender TB130	Trifase

MODELS AVAILABLE

Article	Description	Tension
TB130PT	Topbender TB130	Three phase

CARATTERISTICHE

- Con Controllo TCPlus
- Touch screen a colori 7"
- Icone rinnovate per un facile utilizzo
- Modalità: automatico , MDI manuale, programmazione
- Funzione avanzata di OFFSET
- Cambio lingua immediato
- Auto-tuning dei principali componenti macchina
- Funzione rapida di cambio unità di misura (mm-pollici)
- Velocità di curvatura programmabile per ogni singola curva del programma
- Possibilità di programmi illimitati su Porta USB (optional)
- Ogni singolo programma può contenere fino a 30 curve
- Possibilità di curvare a destra e sinistra
- Possibilità di aggiungere banco posizionatore

FEATURES

- TCPlus control
- 7" colour touch screen
- Icons for ease use
- Automatic mode, MDI manual mode, programming mode
- Advanced OFFSET function
- Easy language change
- Auto-tuning of the main machine components
- Programmable bending speed for each single bend of the program
- Unlimited programs possibility on USB port (optional)
- Every program can contain up to 30 different bends
- Possibility to bend left and right
- Positioning Device (optional)



TCPlus Control



DATI TECNICI / TECHNICAL DATA

Modulo di Flessione Flexion Modulus	80 cm ³
Min Diametro Esterno Min. outside diameter	10 mm 1/8" Gas
Raggio Max. di Curvatura (CLR) Max bending radius (CLR)	700 mm
Raggio Min. di Curvatura (CLR) Min bending radius (CLR)	36 mm
Potenza Installata Motor	3,5 kW
Tensione di alimentazione Voltage requirement	400 V3PH/50-60 Hz
Velocità di curvatura Bending speed	0 - 0,75 rpm
Dimensioni Dimensions	850 x 850 x 1200 mm
Peso Weight	720 Kg

DOTAZIONE DI SERIE

- Alberi Esagonali da 110, 80, 50 e 40 mm
- Supporto per esagono da 40 e 50 mm
- Volantino
- Chiave esagonale da 6mm
- Grasso spray Ercolina
- Ingrassatore
- Estensione della contromatrice

STANDARD EQUIPMENT

- 110, 80, 50 mm and 40 mm hex shafts
- Adapter for 40 and 50 mm hexagon
- Handwheel
- 6mm allen wrench key
- Ercolina grease spray
- Pump for grease
- Counterbending die extension



MATRICE CON ROTAZIONE DX E SX
FORMER L/R BENDING

MAXIMUM CAPACITY - (mm)

SEZ.	MATERIALE - MATERIAL	80 cm ³
	Tubo AnsiB36, 10 e API - Gas Tube	4" x8,56
	Tubo standard acciaio - Standard Steel Tube	127x7,1
	Tubo Mobilio - Forniture tube	127x7,1
	Acciaio ST35 (per oleod.) - Hydraulic Steel ST35	50x10
	Inox AISI 304-318 - Stainless Steel AISI 304-318	114,3x5,6
	Inox AISI 308 (per alim.) - Stainless Steel AISI 308	114,3x5,6
	Ottone ricotto - Soft Brass	139,7x8,8
	Alluminio curvabile - Hard Copper & Aluminium	139,7x8,8
	Rame ricotto - Soft Copper	64x6
	Tubo Conduit (TAZ) - Conduit Tube (TAZ)	88,9x3,65
	Mepla, Geberit e simili - Mepla, Geberit and similars	50x4
	Acciaio FE42 (EN: S275J0) - Mild Steel (EN: S275J0)	90
	Acciaio FE42 (EN:S275J0) - Mild Steel (EN: S275J0)	100x50
	Acciaio FE42 (EN:S275J0) - Mild Steel (EN: S275J0)	130x25
	Acciaio FE42 (EN:S275J0) - Mild Steel (EN: S275J0)	130x60
	Acciaio FE42 (EN:S275J0) - Mild Steel (EN: S275J0)	120x40x10
	Acciaio FE42 (EN:S275J0) - Mild Steel (EN: S275J0)	120x50x11
	Acciaio FE42:(EN:S275J0) - Mild Steel (EN: S275J0)	120x60x9
	Acciaio FE42 (EN:S275J0) - Mild Steel (EN: S275J0)	90x90x10
	Acciaio FE42 (EN:S275J0) - Mild Steel (EN: S275J0)	75x75
	Acciaio FE42 (EN:S275J0) - Mild Steel (EN: S275J0)	100x100x10
	Acciaio FE42 (EN:S275J0) - Mild Steel (EN: S275J0)	100x100x8

MODELLI DISPONIBILI

Articolo	Descrizione	Alimentazione
TB100PT	Topbender TB100	Trifase

MODELS AVAILABLE

Article	Description	Tension
TB100PT	Topbender TB100	Three phase

CARATTERISTICHE

- Con Controllo TCPlus
- Touch screen a colori 7"
- Icone rinnovate per un facile utilizzo
- Modalità: automatico , MDI manuale, programmazione
- Funzione avanzata di OFFSET
- Cambio lingua immediato
- Auto-tuning dei principali componenti macchina
- Funzione rapida di cambio unità di misura (mm-pollici)
- Velocità di curvatura programmabile per ogni singola curva del programma
- Possibilità di programmi illimitati su Porta USB (optional)
- Ogni singolo programma può contenere fino a 30 curve
- Possibilità di curvare a destra e sinistra
- Possibilità di aggiungere banco posizionatore

FEATURES

- TCPlus control
- 7" colour touch screen
- Icons for ease use
- Automatic mode, MDI manual mode, programming mode
- Advanced OFFSET function
- Easy language change
- Auto-tuning of the main machine components
- Programmable bending speed for each single bend of the program
- Unlimited programs possibility on USB port (optional)
- Every program can contain up to 30 different bends
- Possibility to bend left and right
- Positioning Device (optional)



DATI TECNICI / TECHNICAL DATA

Modulo di Flessione Flexion Modulus	43 cm ³
Min Diametro Esterno Min. outside diameter	10 mm 1/8" Gas
Raggio Max. di Curvatura (CLR) Max bending radius (CLR)	400 mm
Raggio Min. di Curvatura (CLR) Min bending radius (CLR)	36 mm
Potenza Installata Motor	3,5 kW
Tensione di alimentazione Voltage requirement	400 V3PH/50-60 Hz
Velocità di curvatura Bending speed	0 - 1,3 rpm
Dimensioni Dimensions	500 x 850 x 1200 mm
Peso Weight	480 Kg

DOTAZIONE DI SERIE

- Esagono da 80, 50, 40 mm
- Supporto per esagono da 40 e 50 mm
- Volantino
- Chiave esagonale da 6mm
- Grasso spray Ercolina
- Ingrassatore

STANDARD EQUIPMENT

- 80, 50 and 40mm hex shafts
- Adapter for 40 and 50 mm hexagon
- Handwheel
- 6mm allen wrench key
- Ercolina grease spray
- Pump for grease

**MATRICE CON ROTAZIONE DX E SX
FORMER L/R BENDING**
MAXIMUM CAPACITY - (mm)

SEZ.	MATERIALE - MATERIAL	43 cm ³
	Tubo AnsiB36, 10 e API - Gas Tube	3"1/2 x4
	Tubo standard acciaio - Standard Steel Tube	100x6
	Tubo Mobilio - Forniture tube	100x6
	Acciaio ST35 (per oleod.) - Hydraulic Steel ST35	50x10
	Inox AISI 304-318 - Stainless Steel AISI 304-318	100x3,6
	Inox AISI 308 (per alim.) - Stainless Steel AISI 308	100x3,6
	Ottone ricotto - Soft Brass	114,3x6,3
	Alluminio curvabile - Hard Copper & Aluminium	114,3x6,3
	Rame ricotto - Soft Copper	114,4x6,3
	Tubo Conduit (TAZ) - Conduit Tube (TAZ)	88,9x3,65
	Mepla, Geberit e simili - Mepla, Geberit and similars	100x5
	Acciaio FE42 (EN: S275J0) - Mild Steel (EN: S275J0)	70
	Acciaio FE42 (EN:S275J0) - Mild Steel (EN: S275J0)	80x40
	Acciaio FE42 (EN:S275J0) - Mild Steel (EN: S275J0)	100x25
	Acciaio FE42 (EN:S275J0) - Mild Steel (EN: S275J0)	100x50
	Acciaio FE42 (EN:S275J0) - Mild Steel (EN: S275J0)	100x50x6,3
	Acciaio FE42 (EN:S275J0) - Mild Steel (EN: S275J0)	100x60x9
	Acciaio FE42:(EN:S275J0) - Mild Steel (EN: S275J0)	100x60x4
	Acciaio FE42 (EN:S275J0) - Mild Steel (EN: S275J0)	90x90x4
	Acciaio FE42 (EN:S275J0) - Mild Steel (EN: S275J0)	60x60
	Acciaio FE42 (EN:S275J0) - Mild Steel (EN: S275J0)	90x90x6
	Acciaio FE42 (EN:S275J0) - Mild Steel (EN: S275J0)	90x90x6

MODELLI DISPONIBILI

Articolo	Descrizione	Alimentazione
TB80PT	Topbender TB80	Trifase

MODELS AVAILABLE

Article	Description	Tension
TB80PT	Topbender TB80	Three phase

CARATTERISTICHE

- Con Controllo TCPlus
- Touch screen a colori 7"
- Icone rinnovate per un facile utilizzo
- Modalità: automatico, MDI manuale, programmazione
- Funzione avanzata di OFFSET
- Cambio lingua immediato
- Auto-tuning dei principali componenti macchina
- Funzione rapida di cambio unità di misura (mm-pollici)
- Velocità di curvatura programmabile per ogni singola curva del programma
- Possibilità di programmi illimitati su Porta USB (optional)
- Ogni singolo programma può contenere fino a 30 curve
- Possibilità di curvare a destra e sinistra
- Possibilità di aggiungere banco anima

FEATURES

- TCPlus control
- 7" colour touch screen
- Icons for ease use
- Automatic mode, MDI manual mode, programming mode
- Advanced OFFSET function
- Easy language change
- Auto-tuning of the main machine components
- Programmable bending speed for each single bend of the program
- Unlimited programs possibility on USB port (optional)
- Every program can contain up to 30 different bends
- Possibility to bend left and right
- Possibility to add a mandrel table



Centro di lubrificazione cuscinetti e boccole inferiori
Lubrication points for lower bearings and bushings

DATI TECNICI / TECHNICAL DATA

Modulo di Flessione Flexion Modulus	20 cm ³
Min Diametro Esterno Min. outside diameter	10 mm 1/8" Gas
Raggio Max. di Curvatura (CLR) Max bending radius (CLR)	420 mm
Raggio Min. di Curvatura (CLR) Min bending radius (CLR)	36 mm
Potenza Installata Motor	3,0 kW
Tensione di alimentazione Voltage requirement	400 V/480 3PH 50-60 Hz
Velocità di curvatura Bending speed	1,5 / 3,0 rpm
Dimensioni Dimensions	1145 x 639 x 990 mm
Peso Weight	500 Kg

DOTAZIONE DI SERIE

- Alberi Esagonali da 80, 50 e 40mm
- Supporto per esagono da 40 e 50 mm
- Supporto per contromatrice
- Volantino
- Chiave esagonale da 6mm
- Grasso spray Ercolina
- Ingrassatore

STANDARD EQUIPMENT

- 80, 50mm and 40mm hex shafts
- Adapter for 40 and 50 mm hexagon
- Counterbending die support
- Handwheel
- 6mm allen wrench key
- Ercolina grease spray
- Pump for grease



MATRICE CON ROTAZIONE DX E SX
FORMER L/R BENDING

MAXIMUM CAPACITY - (mm)

SEZ.	MATERIALE - MATERIAL	20 cm ³
	Tubo AnsiB36, 10 e API - Gas Tube	2"1/2x5.16
	Tubo standard acciaio - Standard Steel Tube	76.1x5.4
	Tubo Mobilio - Forniture tube	76x2
	Acciaio ST35 (per oleod.) - Hydraulic Steel ST35	50x10
	Inox AISI 304-318 - Stainless Steel AISI 304-318	76,1x3,2
	Inox AISI 308 (per alim.) - Stainless Steel AISI 308	76,1x3,2
	Ottone ricotto - Soft Brass	76,1x14,2
	Alluminio curvabile - Hard Copper & Aluminium	76,1x6,3
	Rame ricotto - Soft Copper	76,1x16
	Tubo Conduit (TAZ) - Conduit Tube (TAZ)	76,3x3,65
	Mepla, Geberit e simili - Mepla, Geberit and similars	75x9,7
	Acciaio FE42 (EN: S275J0) - Mild Steel (EN: S275J0)	55
	Acciaio FE42 (EN:S275J0) - Mild Steel (EN: S275J0)	75x20
	Acciaio FE42 (EN:S275J0) - Mild Steel (EN: S275J0)	75x20
	Acciaio FE42 (EN:S275J0) - Mild Steel (EN: S275J0)	75x30
	Acciaio FE42 (EN:S275J0) - Mild Steel (EN: S275J0)	70x40x6
	Acciaio FE42 (EN:S275J0) - Mild Steel (EN: S275J0)	70x50x6
	Acciaio FE42:(EN:S275J0) - Mild Steel (EN: S275J0)	70x50x5
	Acciaio FE42 (EN:S275J0) - Mild Steel (EN: S275J0)	74x75x3
	Acciaio FE42 (EN:S275J0) - Mild Steel (EN: S275J0)	45x45
	Acciaio FE42 (EN:S275J0) - Mild Steel (EN: S275J0)	70x70x9
	Acciaio FE42 (EN:S275J0) - Mild Steel (EN: S275J0)	65x42x5,5

MODELLI DISPONIBILI

Articolo	Descrizione	Alimentazione
MG030V2T	2 velocità	Trifase
MG030PT	con controllo TCPlus	Trifase
MG030PM	con controllo TCPlus	Monofase

CARATTERISTICHE

- Capacità Tubo Standard Acciaio: 76 x 3 mm
- Capacità Tubo Gas: 2 1/2" Gas x 4 mm
- Capacità Tubolare Quadro (FE42): 60x60x3 mm
- Ampio raggio di curvatura: da R10 a R380 mm
- Controllo TCPLUS (MG030PT - MG030PM)
- Asse C di curvatura elettromeccanico con visualizzazione digitale valori
- Controllo micrometrico con visualizzazione di posizione dell'asse X
- Possibilità di programmi illimitati (con controllo TCPlus); capacità di programmare e memorizzare 30 programmi da 9 curve ciascuno comprese l'angolo di recupero (relativo all'elasticità del materiale) sul modello MG030V2T
- Disponibile modello a due velocità di curvatura (MG030V2T) o con sistema inverter a velocità variabile (con controllo TCPlus)
- Sistema di controllo di sovraccarico con spie lampeggianti di segnalazione
- Possibilità di adattare (optional) un posizionatore a due assi (A40/P) per consentire la produzione in serie di curvaturei su piani differenti
- Sistema cambio utensili semplice e veloce (Brevetto Ercolina)
- Facile da spostare grazie alle ruote incorporate e alla maniglia retrattile
- Comando a pedale
- Matrice con rotazione destra e sinistra (optional per controllo TCPlus)
- Possibilità di aggiungere banco anima

MODELS AVAILABLE

Article	Description	Tension
MG030V2T	2 speeds	Three phase
MG030PT	TCPlus control	Three phase
MG030PM	TCPlus control	Single phase

FEATURES

- Standard steel tube capacity 76 x 3 mm
- Pipe capacity 2-1/2" Sch. 10
- Square tube capacity 60 x 60 x 3 mm
- Large bending radius: R10 to R380 mm
- TCPLUS Control (MG030PT - MG030PM)
- Electromechanical bending axis C with digital value display
- Micrometric control with X-axis position display
- Unlimited programs possibility (with TCPlus control); ability to program and store 30 programs with 9 curves each including the recovery angle (relative to the elasticity of the material) on MG030V2T model
- Available model with two bending speeds (MG030V2T) or with variable speed inverter system (with TCPlus control)
- Overload control system with flashing warning lights
- Possibility to adapt (optional) a two-axis positioner (A40/P) to allow series production of bends in different planes
- Quick and easy tool change system (Ercolina Patent)
- Easy to move thanks to the built-in wheels and retractable handle
- Foot pedal control
- Former L/R bending (optional for TCPlus control)
- Possibility to add a mandrel table



MEGA BENDER
MG030PT



MEGA BENDER
MG030V2T



DATI TECNICI / TECHNICAL DATA

Modulo di Flessione Flexion Modulus	15 cm ³
Min Diametro Esterno Min. outside diameter	5 mm
Raggio Max. di Curvatura (CLR) Max bending radius (CLR)	380 mm
Raggio Min. di Curvatura (CLR) Min bending radius (CLR)	10 mm
Potenza Installata Motor	3,5 kW
Tensione di alimentazione Voltage requirement	220-400 V 3PH 50-60 Hz
Velocità di curvatura Bending speed	0,62 rpm
Dimensioni Dimensions	680 x 910 x 370 mm
Peso Weight	193 Kg

DOTAZIONE DI SERIE

- Esagono da 50 e 40 mm
- Supporto per contromatrice
- Volantino
- Chiave esagonale da 6mm
- Grasso spray Ercolina
- Ingrassatore

STANDARD EQUIPMENT

- 50 and 40mm hex shafts
- Counterbending die support
- Handwheel
- 6mm allen wrench key
- Ercolina grease spray
- Pump for grease

**kit macchina + utensili
(matrice e contromatrice)***

**machine kit + tooling
(former & counterbending die)***

Art.	Macchina Machine	Tubo/Tube	Ø	Matrici/Formers
MG030V2TK2D	MG030V2T	Pollici gas Gas inches	2 x 0	0 1/2" (21.30 mm), R46 0 3/4" (26.90 mm), R56 0 1" (33.70 mm), R67 0 1" 1/4 (42.25 mm), R90 0 1" 1/2 (48.25 mm), R100 0 2 (60.30 mm), R150
MG030V2TK2D	MG030V2T	Pollici gas Gas inches	3 x 0	0 1/2" (21.30 mm), R67 0 3/4" (26.90 mm), R82 0 1" (33.70 mm), R112 0 1" 1/4 (42.25 mm), R130 0 1" 1/2 (48.25 mm), R150 0 2 (60.30 mm), R190
MG030V2TK2D	MG030V2T	Pollici OD OD inches	/	0 5/8" (15.88 mm), R46 0 7/8" (22.22 mm), R56 0 1" (28.40 mm), R67 0 1" 1/4 (31.75 mm), R56 0 1" 1/2 (38.10 mm), R100 0 2 (50.80 mm), R150

*Matrici in ghisa, contromatrici in ottone

*Formers in cast iron, counterbending dies in brass

MAXIMUM CAPACITY - (mm)

SEZ.	MATERIALE - MATERIAL	15 cm ³
	Tubo AnsiB36, 10 e API - Gas Tube	2"x5,54
	Tubo standard acciaio - Standard Steel Tube	76x3
	Tubo Mobilio - Forniture tube	76x3
	Acciaio ST35 (per oleod.) - Hydraulic Steel ST35	50x10
	Inox AISI 304-318 - Stainless Steel AISI 304-318	70x4
	Inox AISI 308 (per alim.) - Stainless Steel AISI 308	76x1,6
	Ottone ricotto - Soft Brass	76x4
	Alluminio curvabile - Hard Copper & Aluminium	76x6
	Rame ricotto - Soft Copper	76x6
	Tubo Conduit (TAZ) - Conduit Tube (TAZ)	76,3x3,25
	Mepla, Geberit e simili - Mepla, Geberit and similars	50x4
	Acciaio FE42 (EN: S275J0) - Mild Steel (EN: S275J0)	45
	Acciaio FE42 (EN:S275J0) - Mild Steel (EN: S275J0)	10x90
	Acciaio FE42 (EN:S275J0) - Mild Steel (EN: S275J0)	75x15
	Acciaio FE42 (EN:S275J0) - Mild Steel (EN: S275J0)	75x30
	Acciaio FE42 (EN:S275J0) - Mild Steel (EN: S275J0)	70x40x4
	Acciaio FE42 (EN:S275J0) - Mild Steel (EN: S275J0)	70x40x8
	Acciaio FE42 (EN:S275J0) - Mild Steel (EN: S275J0)	30x60 x 3
	Acciaio FE42 (EN:S275J0) - Mild Steel (EN: S275J0)	60x60 x 3
	Acciaio FE42 (EN:S275J0) - Mild Steel (EN: S275J0)	40x40
	Acciaio FE42 (EN:S275J0) - Mild Steel (EN: S275J0)	60x60 x 6
	Acciaio FE42 (EN:S275J0) - Mild Steel (EN: S275J0)	50x20 x 6



MODELLI DISPONIBILI

Articolo	Descrizione	Alimentazione
MG030EDTP-M	con controllo EDTPlus	Monofase
MG030EDTP-T	con controllo EDTPlus	Trifase

MODELS AVAILABLE

Article	Description	Tension
MG030EDTP-M	EDTPlus control	Single phase
MG030EDTP-T	EDTPlus control	Three phase

CARATTERISTICHE

- Controllo semplice ed intuitivo EDT PLUS
- Ampio raggio di curvatura: da R10 a R380 mm
- Schermo ad alta risoluzione da 4,3"
- Programmazione multilingua
- Programmazione angolo di curvatura con inserimento del valore della compensazione del ritorno elastico
- Visualizzazione della percentuale di carico in fase di curvatura
- Rapido cambio Utensili
- Inverter
- Predisposizione per installazione dell'accessorio posizionatore oscillante su due assi A40-P, idoneo a realizzare curve in sequenza, garantendone la ripetibilità
- Comando a pedale

FEATURES

- Simple and intuitive control EDT PLUS
- Bending radius: from R10 to R380 mm
- 4.3 "high resolution screen
- Multilingual
- Programming the bend angle and the value of the springback compensation
- Display of the percentage of load during bending
- Quick tooling change
- Inverter
- Possibility to mount the oscillating positioner accessory on two axes A40-P, suitable for making bends in sequence, ensuring repeatability
- Foot pedal control



MATRICE CON ROTAZIONE DX E SX
FORMER L/R BENDING



CONTROLLO EDT PLUS



DATI TECNICI / TECHNICAL DATA

Modulo di Flessione Flexion Modulus	15 cm ³
Min Diametro Esterno Min. outside diameter	5 mm
Raggio Max. di Curvatura (CLR) Max bending radius (CLR)	380 mm
Raggio Min. di Curvatura (CLR) Min bending radius (CLR)	10 mm
Potenza Installata Motor	3,5 kW
Tensione di alimentazione Voltage requirement	220-400 V 3PH 50-60 Hz
Velocità di curvatura Bending speed	0,62 rpm
Dimensioni Dimensions	680 x 910 x 370 mm
Peso Weight	193 Kg

DOTAZIONE DI SERIE

- Esagono da 50 e 40 mm
- Supporto per contromatrice
- Volantino
- Chiave esagonale da 6mm
- Grasso spray Ercolina
- Ingrassatore

STANDARD EQUIPMENT

- 50 and 40mm hex shafts
- Counterbending die support
- Handwheel
- 6mm allen wrench key
- Ercolina grease spray
- Pump for grease

kit macchina + utensili (matrice e contromatrice)*























machine kit + tooling (former & counterbending die)*

Art.	Macchina Machine	Tubo/Tube	Ø	Matrici/Formers
MG030V2TK2D	MG030V2T	Pollici gas Gas inches	2 x 0	0 1/2" (21.30 mm), R46 0 3/4" (26.90 mm), R56 0 1" (33.70 mm), R67 0 1" 1/4 (42.25 mm), R90 0 1" 1/2 (48.25 mm), R100 0 2 (60.30 mm), R150
MG030V2TK2D	MG030V2T	Pollici gas Gas inches	3 x 0	0 1/2" (21.30 mm), R67 0 3/4" (26.90 mm), R82 0 1" (33.70 mm), R112 0 1" 1/4 (42.25 mm), R130 0 1" 1/2 (48.25 mm), R150 0 2 (60.30 mm), R190
MG030V2TK2D	MG030V2T	Pollici OD OD inches	/	0 5/8" (15.88 mm), R46 0 7/8" (22.22 mm), R56 0 1" (28.40 mm), R67 0 1" 1/4 (31.75 mm), R56 0 1" 1/2 (38.10 mm), R100 0 2 (50.80 mm), R150

*Matrici in ghisa, contromatrici in ottone

*Formers in cast iron, counterbending dies in brass

MAXIMUM CAPACITY - (mm)

SEZ.	MATERIALE - MATERIAL	15 cm ³
	Tubo AnsiB36, 10 e API - Gas Tube	2"x5,54
	Tubo standard acciaio - Standard Steel Tube	76x3
	Tubo Mobilio - Forniture tube	76x3
	Acciaio ST35 (per oleod.) - Hydraulic Steel ST35	50x10
	Inox AISI 304-318 - Stainless Steel AISI 304-318	70x4
	Inox AISI 308 (per alim.) - Stainless Steel AISI 308	76x1,6
	Ottone ricotto - Soft Brass	76x4
	Alluminio curvabile - Hard Copper & Aluminium	76x6
	Rame ricotto - Soft Copper	76x6
	Tubo Conduit (TAZ) - Conduit Tube (TAZ)	76,3x3,25
	Mepla, Geberit e simili - Mepla, Geberit and similars	50x4
	Acciaio FE42 (EN: S275J0) - Mild Steel (EN: S275J0)	45
	Acciaio FE42 (EN:S275J0) - Mild Steel (EN: S275J0)	10x90
	Acciaio FE42 (EN:S275J0) - Mild Steel (EN: S275J0)	75x15
	Acciaio FE42 (EN:S275J0) - Mild Steel (EN: S275J0)	75x30
	Acciaio FE42 (EN:S275J0) - Mild Steel (EN: S275J0)	70x40x4
	Acciaio FE42 (EN:S275J0) - Mild Steel (EN: S275J0)	70x40x8
	Acciaio FE42 (EN:S275J0) - Mild Steel (EN: S275J0)	30x60 x 3
	Acciaio FE42 (EN:S275J0) - Mild Steel (EN: S275J0)	60x60 x 3
	Acciaio FE42 (EN:S275J0) - Mild Steel (EN: S275J0)	40x40
	Acciaio FE42 (EN:S275J0) - Mild Steel (EN: S275J0)	60x60 x 6
	Acciaio FE42 (EN:S275J0) - Mild Steel (EN: S275J0)	50x20 x 6



MODELLI DISPONIBILI

Articolo	Descrizione	Alimentazione
TB60PT	TopBender TB60T	Trifase
TB60TK2D	2xD kit Gas	Trifase
TB60TK3D	3xD kit Gas	Trifase
TB60KOD	OD kit	Trifase

CARATTERISTICHE

- Capacità Tubo Standard Acciaio: 60 x 4 mm
- Capacità Tubo Gas: 2" Gas x 4 mm
- Capacità Tubo Quadro (FE42): 50x50x3 mm
- Ampio raggio di curvatura: da R10 a R380 mm
- Controllo TCPLUS (TB60PT)
- Asse C di curvatura elettromeccanico con visualizzazione digitale valori
- Controllo micrometrico con visualizzazione di posizione dell'asse X
- Capacità di programmare e memorizzare 30 programmi da 9 curve ciascuno comprese l'angolo di recupero (relativo all'elasticità del materiale)
- Due velocità di curvatura
- Sistema di controllo di sovraccarico con spie lampeggianti di segnalazione
- Possibilità di adattare (optional) un posizionatore a due assi (A40/P) per consentire la produzione in serie di curvaturei su piani differenti
- Sistema cambio utensili semplice e veloce (Brevetto Ercolina)
- Facile da spostare grazie alle ruote incorporate e alla maniglia retrattile.
- Comando a pedale
- Doppia velocità

MODELS AVAILABLE

Article	Description	Tension
TB60PT	TopBender TB60T	Three phase
TB60TK2D	2xD Gas kit	Three phase
TB60TK3D	3xD Gas kit	Three phase
TB60KOD	OD kit	Three phase

FEATURES

- Mild steel tube capacity 60 x 4 mm
- 2" Gas inches (4 mm) capacity
- Square tube capacity 50 x 50 x 3 mm
- Maximum CLR 380 mm
- TCPLUS Control (TB60PT)
- Electromechanical bending axis C with digital value display
- Micrometric control with X-axis position display
- Ability to program and store 30 programs with 9 curves each including the recovery angle (relative to the elasticity of the material)
- Double Bending Speed
- Overload control system with flashing warning lights
- Possibility to adapt (optional) a two-axis positioner (A40/P) to allow series production of bends in different planes
- Quick and easy tool change system (Ercolina Patent)
- Easy to move thanks to the built-in wheels and retractable handle
- Foot pedal control
- Two bending speed



MATRICE CON ROTAZIONE DX E SX
FORMER L/R BENDING



DATI TECNICI / TECHNICAL DATA

Modulo di Flessione Flexion Modulus	10 cm ³
Min Diametro Esterno Min. outside diameter	5 mm
Raggio Max. di Curvatura (CLR) Max bending radius (CLR)	380 mm
Raggio Min. di Curvatura (CLR) Min bending radius (CLR)	10 mm
Potenza Installata Motor	1,5 kW
Tensione di alimentazione Voltage requirement	220-400 V 3PH 50-60 Hz
Velocità di curvatura Bending speed	1,5 - 3 rpm
Dimensioni Dimensions	500 x 1000 x 760 mm
Peso Weight	186 Kg

DOTAZIONE DI SERIE

- Esagono da 50 e 40 mm
- Supporto per contromatrice
- Volantino
- Chiave esagonale da 6mm
- Grasso spray Ercolina
- Ingrassatore

STANDARD EQUIPMENT

- 50 and 40mm hex shafts
- Counterbending die support
- Handwheel
- 6mm allen wrench key
- Ercolina grease spray
- Pump for grease























kit macchina + utensili
(matrice e contromatrice)*machine kit + tooling
(former & counterbending die)*

Art.	Macchina Machine	Tubo/Tube	Ø	Matrici/Formers
TB60T K2D	TB60T	Pollici gas Gas inches	2 x 0	Ø 1/2" (21.30 mm), R46
				Ø 3/4" (26.90 mm), R56
TB60T K3D	TB60T	Pollici gas Gas inches	3 x 0	Ø 1" (33.70 mm), R67
				Ø 1" 1/4 (42.25 mm), R90
				Ø 1" 1/2 (48.25 mm), R100
				Ø 2 (60.30 mm), R150
				Ø 1/2" (21.30 mm), R67
TB60T KOD	TB60T	Pollici OD OD inches	/	Ø 3/4" (26.90 mm), R82
				Ø 1" (33.70 mm), R112
				Ø 1" 1/4 (42.25 mm), R130
				Ø 1" 1/2 (48.25 mm), R150
				Ø 2 (60.30 mm), R190
TB60T KOD	TB60T	Pollici OD OD inches	/	Ø 5/8" (15.88 mm), R46
				Ø 7/8" (22.22 mm), R56
				Ø 1" (28.40 mm), R67
				Ø 1" 1/4 (31.75 mm), R56
				Ø 1" 1/2 (38.10 mm), R100
Ø 2 (50.80 mm), R150				

*Matrici in ghisa, contromatrici in ottone

*Formers in cast iron, counterbending dies in brass

MAXIMUM CAPACITY - (mm)

SEZ.	MATERIALE - MATERIAL	10 cm ³
	Tubo AnsiB36, 10 e API - Gas Tube	2" x3,91
	Tubo standard acciaio - Standard Steel Tube	60x4
	Tubo Mobilio - Forniture tube	60x4
	Acciaio ST35 (per oleod.) - Hydraulic Steel ST35	50x10
	Inox AISI 304-318 - Stainless Steel AISI 304-318	60x2
	Inox AISI 308 (per alim.) - Stainless Steel AISI 308	60x3
	Ottone ricotto - Soft Brass	60x6
	Alluminio curvabile - Hard Copper & Aluminium	64x6
	Rame ricotto - Soft Copper	64x6
	Tubo Conduit (TAZ) - Conduit Tube (TAZ)	63x4
	Mepla, Geberit e simili - Mepla, Geberit and similars	50x4
	Acciaio FE42 (EN: S275J0) - Mild Steel (EN: S275J0)	35
	Acciaio FE42 (EN:S275J0) - Mild Steel (EN: S275J0)	14x60
	Acciaio FE42 (EN:S275J0) - Mild Steel (EN: S275J0)	60x20
	Acciaio FE42 (EN:S275J0) - Mild Steel (EN: S275J0)	60x35
	Acciaio FE42 (EN:S275J0) - Mild Steel (EN: S275J0)	60x30x6
	Acciaio FE42 (EN:S275J0) - Mild Steel (EN: S275J0)	60x40x7
	Acciaio FE42 (EN:S275J0) - Mild Steel (EN: S275J0)	25x50 x 3
	Acciaio FE42 (EN:S275J0) - Mild Steel (EN: S275J0)	50x50 x 3
	Acciaio FE42 (EN:S275J0) - Mild Steel (EN: S275J0)	30x30
	Acciaio FE42 (EN:S275J0) - Mild Steel (EN: S275J0)	50x50 x 6
	Acciaio FE42 (EN:S275J0) - Mild Steel (EN: S275J0)	40x20 x 6



MODELLI DISPONIBILI

Articolo	Descrizione	Alimentazione
TB60EDTP-M	Topbender TB60EDT-M	Monofase
TB60EDTP-T	Topbender TB60EDT-T	Trifase

CARATTERISTICHE

- Controllo semplice ed intuitivo EDT PLUS
- Schermo ad alta risoluzione da 4,3"
- Programmazione multilingua
- Programmazione angolo di curvatura con inserimento del valore della compensazione del ritorno elastico
- Visualizzazione della percentuale di carico in fase di curvatura
- Rapido cambio Utensili
- Inverter
- Predisposizione per installazione dell'accessorio posizionatore oscillante su due assi A40-P, idoneo a realizzare curve in sequenza, garantendone la ripetibilità
- Comando a pedale
- Doppia velocità



CONTROLLO EDT PLUS

MATRICE CON ROTAZIONE DX E SX
FORMER L/R BENDING

MODELS AVAILABLE

Article	Description	Tension
TB60EDTP-M	Topbender TB60EDT-M	Single phase
TB60EDTP-T	Topbender TB60EDT-T	Three phase

FEATURES

- Simple and intuitive control EDT PLUS
- 4.3 "high resolution screen
- Multilingual
- Programming the bend angle and the value of the springback compensation
- Display of the percentage of load during bending
- Quick tooling change
- Inverter
- Possibility to mount the oscillating positioner accessory on two axes A40-P, suitable for making bends in sequence, ensuring repeatability
- Foot pedal control
- Two bending speed



DATI TECNICI / TECHNICAL DATA

Modulo di Flessione Flexion Modulus	10 cm ³
Min Diametro Esterno Min. outside diameter	5 mm
Raggio Max. di Curvatura (CLR) Max bending radius (CLR)	380 mm
Raggio Min. di Curvatura (CLR) Min bending radius (CLR)	10 mm
Potenza Installata Motor	1,5 kW
Tensione di alimentazione Voltage requirement	220-400 V 3PH 50-60 Hz
Velocità di curvatura Bending speed	1,5 - 3 rpm
Dimensioni Dimensions	500 x 1000 x 760 mm
Peso Weight	186 Kg

DOTAZIONE DI SERIE

- Esagono da 50 e 40 mm
- Supporto per contromatrice
- Volantino
- Chiave esagonale da 6mm
- Grasso spray Ercolina
- Ingrassatore

STANDARD EQUIPMENT

- 50 and 40mm hex shafts
- Counterbending die support
- Handwheel
- 6mm allen wrench key
- Ercolina grease spray
- Pump for grease

kit macchina + utensili (matrice e contromatrice)*

machine kit + tooling (former & counterbending die)*

Art.	Macchina Machine	Tubo/Tube	Ø	Matrici/Formers
TB60T K2D	TB60T	Pollici gas Gas inches	2 x 0	Ø 1/2" (21.30 mm), R46
				Ø 3/4" (26.90 mm), R56
TB60T K3D	TB60T	Pollici gas Gas inches	3 x 0	Ø 1" (33.70 mm), R67
				Ø 1 1/4 (42.25 mm), R90
				Ø 1 1/2 (48.25 mm), R100
				Ø 2 (60.30 mm), R150
				Ø 1/2" (21.30 mm), R67
TB60T KOD	TB60T	Pollici OD OD inches	/	Ø 3/4" (26.90 mm), R82
				Ø 1" (33.70 mm), R112
				Ø 1 1/4 (42.25 mm), R130
				Ø 1 1/2 (48.25 mm), R150
				Ø 2 (60.30 mm), R190
TB60T KOD	TB60T	Pollici OD OD inches	/	Ø 5/8" (15.88 mm), R46
				Ø 7/8" (22.22 mm), R56
				Ø 1" (28.40 mm), R67
				Ø 1 1/4 (31.75 mm), R56
				Ø 1 1/2 (38.10 mm), R100
Ø 2 (50.80 mm), R150				

*Matrici in ghisa, contromatrici in ottone

*Formers in cast iron, counterbending dies in brass

MAXIMUM CAPACITY - (mm)

SEZ.	MATERIALE - MATERIAL	10 cm ³
	Tubo AnsiB36, 10 e API - Gas Tube	2" x3,91
	Tubo standard acciaio - Standard Steel Tube	60x4
	Tubo Mobilio - Forniture tube	60x4
	Acciaio ST35 (per oleod.) - Hydraulic Steel ST35	50x10
	Inox AISI 304-318 - Stainless Steel AISI 304-318	60x2
	Inox AISI 308 (per alim.) - Stainless Steel AISI 308	60x3
	Ottone ricotto - Soft Brass	60x6
	Alluminio curvabile - Hard Copper & Aluminium	64x6
	Rame ricotto - Soft Copper	64x6
	Tubo Conduit (TAZ) - Conduit Tube (TAZ)	63x4
	Mepla, Geberit e simili - Mepla, Geberit and similars	50x4
	Acciaio FE42 (EN: S275J0) - Mild Steel (EN: S275J0)	35
	Acciaio FE42 (EN:S275J0) - Mild Steel (EN: S275J0)	14x60
	Acciaio FE42 (EN:S275J0) - Mild Steel (EN: S275J0)	60x20
	Acciaio FE42 (EN:S275J0) - Mild Steel (EN: S275J0)	60x35
	Acciaio FE42 (EN:S275J0) - Mild Steel (EN: S275J0)	60x30x6
	Acciaio FE42 (EN:S275J0) - Mild Steel (EN: S275J0)	60x40x7
	Acciaio FE42 (EN:S275J0) - Mild Steel (EN: S275J0)	25x50 x 3
	Acciaio FE42 (EN:S275J0) - Mild Steel (EN: S275J0)	50x50 x 3
	Acciaio FE42 (EN:S275J0) - Mild Steel (EN: S275J0)	30x30
	Acciaio FE42 (EN:S275J0) - Mild Steel (EN: S275J0)	50x50 x 6
	Acciaio FE42 (EN:S275J0) - Mild Steel (EN: S275J0)	40x20 x 6



MODELLI DISPONIBILI

Articolo	Descrizione	Alimentazione
TB50PT	TopBender TB50T	Trifase
TB50TK2D	2xD kit Gas	Trifase
TB50TK3D	3xD kit Gas	Trifase
TB50KOD	OD kit	Trifase

CARATTERISTICHE

- Ampio raggio di curvatura: da R10 a R300 mm
- Controllo TCPLUS (TB50PT)
- Asse C di curvatura elettromeccanico con visualizzazione digitale valori
- Controllo micrometrico con visualizzazione di posizione dell'asse X
- Sistema di controllo di sovraccarico con spie lampeggianti di segnalazione
- Possibilità di adattare (optional) un posizionatore a due assi (A40/P) per consentire la produzione in serie di curvaturei su piani differenti.
- Sistema cambio utensili semplice e veloce (Brevetto Ercolina)
- Facile da spostare grazie alle ruote incorporate e alla maniglia retrattile
- Possibilità di aggiungere banco anima
- Comando a pedale
- Doppia velocità



MATRICE CON ROTAZIONE DX E
FORMER L/R BENDING

MODELS AVAILABLE

Article	Description	Tension
TB50PT	TopBender TB50T	Three phase
TB50TK2D	2xD Gas kit	Three phase
TB50TK3D	3xD Gas kit	Three phase
TB50KOD	OD kit	Three phase

FEATURES

- Maximum CLR 300 mm
- TCPLUS Control (TB50PT)
- Electromechanical bending axis C with digital value display
- Micrometric control with X-axis position display
- Overload control system with flashing warning lights
- Possibility to adapt (optional) a two-axis positioner (A40/P) to allow series production of bends in different planes
- Quick and easy tool change system (Ercolina Patent)
- Easy to move thanks to the built-in wheels and retractable handle
- Possibility to add a mandrel table
- Foot pedal control
- Two bending speed



DATI TECNICI / TECHNICAL DATA

Modulo di Flessione Flexion Modulus	10,5 cm ³
Min Diametro Esterno Min. outside diameter	5 mm
Raggio Max. di Curvatura (CLR) Max bending radius (CLR)	300 mm
Raggio Min. di Curvatura (CLR) Min bending radius (CLR)	10 mm
Potenza Installata Motor	1,5 kW
Tensione di alimentazione Voltage requirement	220-400 V 3PH 50-60 Hz
Velocità di curvatura Bending speed	1,25 - 2,5 rpm
Dimensioni Dimensions	363 x 900 x 595 mm
Peso Weight	130 Kg

DOTAZIONE DI SERIE

- Esagono da 50 e 40 mm
- Supporto per contromatrice
- Volantino
- Chiave esagonale da 6mm
- Grasso spray Ercolina
- Ingrassatore

STANDARD EQUIPMENT

- 50 and 40mm hex shafts
- Counterbending die support
- Handwheel
- 6mm allen wrench key
- Ercolina grease spray
- Pump for grease























kit macchina + utensili
(matrice e contromatrice)*machine kit + tooling
(former & counterbending die)*

Art.	Macchina Machine	Tubo/Tube	Ø	Matrici/Formers
TB50T K2D	TB50T	Pollici gas Gas inches	2 x 0	Ø 1/2" (21.30 mm), R46 Ø 3/4" (26.90 mm), R56 Ø 1" (33.70 mm), R67 Ø 1 1/4 (42.25 mm), R90 Ø 1 1/2 (48.25 mm), R100 Ø 2 (60.30 mm), R150
TB50T K3D	TB50T	Pollici gas Gas inches	3 x 0	Ø 1/2" (21.30 mm), R67 Ø 3/4" (26.90 mm), R82 Ø 1" (33.70 mm), R112 Ø 1 1/4 (42.25 mm), R130 Ø 1 1/2 (48.25 mm), R150 Ø 2 (60.30 mm), R190
TB50T K0D	TB50T	Pollici OD OD inches	/	Ø 5/8" (15.88 mm), R46 Ø 7/8" (22.22 mm), R56 Ø 1" (28.40 mm), R67 Ø 1 1/4 (31.75 mm), R56 Ø 1 1/2 (38.10 mm), R100 Ø 2 (50.80 mm), R150

*Matrici in ghisa, contromatrici in ottone

*Formers in cast iron, counterbending dies in brass

MAXIMUM CAPACITY

SEZ.	MATERIALE - MATERIAL	10.5 cm ³
	Tubo AnsiB36, 10 e API - Gas Tube	2" x3,91
	Tubo standard acciaio - Standard Steel Tube	60x3
	Tubo Mobilio - Forniture tube	60x4
	Acciaio ST35 (per oleod.) - Hydraulic Steel ST35	50x10
	Inox AISI 304-318 - Stainless Steel AISI 304-318	60x2
	Inox AISI 308 (per alim.) - Stainless Steel AISI 308	60x4
	Ottone ricotto - Soft Brass	60x4
	Alluminio curvabile - Hard Copper & Aluminium	64x4
	Rame ricotto - Soft Copper	64x4
	Tubo Conduit (TAZ) - Conduit Tube (TAZ)	60x4
	Mepla, Geberit e simili - Mepla, Geberit and similars	50x4
	Acciaio FE42 (EN: S275J0) - Mild Steel (EN: S275J0)	35
	Acciaio FE42 (EN:S275J0) - Mild Steel (EN: S275J0)	10x60
	Acciaio FE42 (EN:S275J0) - Mild Steel (EN: S275J0)	60x16
	Acciaio FE42 (EN:S275J0) - Mild Steel (EN: S275J0)	60x30
	Acciaio FE42 (EN:S275J0) - Mild Steel (EN: S275J0)	60x30x4
	Acciaio FE42 (EN:S275J0) - Mild Steel (EN: S275J0)	60x40x5
	Acciaio FE42 (EN:S275J0) - Mild Steel (EN: S275J0)	25x50 x 3
	Acciaio FE42 (EN:S275J0) - Mild Steel (EN: S275J0)	50x50 x 3
	Acciaio FE42 (EN:S275J0) - Mild Steel (EN: S275J0)	30x30
	Acciaio FE42 (EN:S275J0) - Mild Steel (EN: S275J0)	50x50 x 6
	Acciaio FE42 (EN:S275J0) - Mild Steel (EN: S275J0)	40x20 x 6



MODELLI DISPONIBILI

Articolo	Descrizione	Alimentazione
TB50EDTP-M	Topbender TB50EDT-M	Monofase
TB50EDTP-T	Topbender TB50EDT-T	Trifase

MODELS AVAILABLE

Article	Description	Tension
TB50EDTP-M	Topbender TB50EDT-M	Single phase
TB50EDTP-T	Topbender TB50EDT-T	Three phase

CARATTERISTICHE

- Capacità Tubo FE42 : 60 x 3mm
- Capacità Tubo Gas: 2" Gas x 4 mm
- Capacità Tubo Quadro (FE 42): 50 x 50 x 3 mm
- Massimo Raggio di Curvatura 300 mm
- Raggio minimo 2 volte il diametro del tubo
- Controllo semplice ed intuitivo.
- Schermo ad alta risoluzione da 4,3"
- Programmazione multilingua
- Programmazione angolo di curvatura con inserimento del valore della compensazione del ritorno elastico
- Visualizzazione della percentuale di carico in fase di curvatura
- Rapido cambio Utensili
- Inverter
- Predisposizione per installazione dell'accessorio posizionatore oscillante su due assi A40-P, idoneo a realizzare curve in sequenza, garantendone la ripetibilità
- Comando a pedale
- Doppia velocità

FEATURES

- FE42 tube capacity: 60 x 3mm
- Gas Hose Capacity: 2" Gas x 4 mm
- Square tube capacity (FE 42): 50 x 50 x 3 mm
- Maximum CLR 300 mm
- Minimum radius 2 times the pipe diameter
- Simple and intuitive EDTPlus control
- 4.3 "high resolution screen
- Multilingual
- Programming the bend angle and the value of the springback compensation
- Display of the percentage of load during bending
- Quick tooling change
- Inverter
- Possibility to mount the oscillating positioner accessory on two axes A40-P, suitable for making bends in sequence, ensuring repeatability
- Foot pedal
- Two bending speed



CONTROLLO EDT PLUS

MATRICE CON ROTAZIONE DX E SX
FORMER L/R BENDING

DATI TECNICI / TECHNICAL DATA

Modulo di Flessione Flexion Modulus	10,5 cm ³
Min Diametro Esterno Min. outside diameter	5 mm
Raggio Max. di Curvatura (CLR) Max bending radius (CLR)	300 mm
Raggio Min. di Curvatura (CLR) Min bending radius (CLR)	10 mm
Potenza Installata Motor	1,5 kW
Tensione di alimentazione Voltage requirement	220-400 V 3PH 50-60 Hz
Velocità di curvatura Bending speed	1,25 - 2,5 rpm
Dimensioni Dimensions	363 x 900 x 595 mm
Peso Weight	130 Kg

DOTAZIONE DI SERIE

- Esagono da 50 e 40 mm
- Supporto per contromatrice
- Volantino
- Chiave esagonale da 6mm
- Grasso spray Ercolina
- Ingrassatore

STANDARD EQUIPMENT

- 50 and 40mm hex shafts
- Counterbending die support
- Handwheel
- 6mm allen wrench key
- Ercolina grease spray
- Pump for grease

**kit macchina + utensili
(matrice e contromatrice)***

**machine kit + tooling
(former & counterbending die)***

Art.	Macchina Machine	Tubo/Tube	Ø	Matrici/Formers
TB50T K2D	TB50T	Pollici gas	2 x Ø	Ø 1/2" (21.30 mm), R46 Ø 3/4" (26.90 mm), R56 Ø 1" (33.70 mm), R67 Ø 1 1/4 (42.25 mm), R90 Ø 1 1/2 (48.25 mm), R100 Ø 2 (60.30 mm), R150
TB50T K3D	TB50T	Pollici gas	3 x Ø	Ø 1/2" (21.30 mm), R67 Ø 3/4" (26.90 mm), R82 Ø 1" (33.70 mm), R112 Ø 1 1/4 (42.25 mm), R130 Ø 1 1/2 (48.25 mm), R150 Ø 2 (60.30 mm), R190
TB50T K0D	TB50T	Pollici OD	/	Ø 5/8" (15.88 mm), R46 Ø 7/8" (22.22 mm), R56 Ø 1" (28.40 mm), R67 Ø 1 1/4 (31.75 mm), R56 Ø 1 1/2 (38.10 mm), R100 Ø 2 (50.80 mm), R150

*Matrici in ghisa, contromatrici in ottone

*Formers in cast iron, counterbending dies in brass

MAXIMUM CAPACITY - (mm)

SEZ.	MATERIALE - MATERIAL	10.5 cm ³
	Tubo AnsiB36, 10 e API - Gas Tube	2" x3,91
	Tubo standard acciaio - Standard Steel Tube	60x3
	Tubo Mobilio - Forniture tube	60x4
	Acciaio ST35 (per oleod.) - Hydraulic Steel ST35	50x10
	Inox AISI 304-318 - Stainless Steel AISI 304-318	60x2
	Inox AISI 308 (per alim.) - Stainless Steel AISI 308	60x4
	Ottone ricotto - Soft Brass	60x4
	Alluminio curvabile - Hard Copper & Aluminium	64x4
	Rame ricotto - Soft Copper	64x4
	Tubo Conduit (TAZ) - Conduit Tube (TAZ)	60x4
	Mepla, Geberit e simili - Mepla, Geberit and similars	50x4
	Acciaio FE42 (EN: S275J0) - Mild Steel (EN: S275J0)	35
	Acciaio FE42 (EN:S275J0) - Mild Steel (EN: S275J0)	10x60
	Acciaio FE42 (EN:S275J0) - Mild Steel (EN: S275J0)	60x16
	Acciaio FE42 (EN:S275J0) - Mild Steel (EN: S275J0)	60x30
	Acciaio FE42 (EN:S275J0) - Mild Steel (EN: S275J0)	60x30x4
	Acciaio FE42 (EN:S275J0) - Mild Steel (EN: S275J0)	60x40x5
	Acciaio FE42:(EN:S275J0) - Mild Steel (EN: S275J0)	25x50 x 3
	Acciaio FE42 (EN:S275J0) - Mild Steel (EN: S275J0)	50x50 x 3
	Acciaio FE42 (EN:S275J0) - Mild Steel (EN: S275J0)	30x30
	Acciaio FE42 (EN:S275J0) - Mild Steel (EN: S275J0)	50x50 x 6
	Acciaio FE42 (EN:S275J0) - Mild Steel (EN: S275J0)	40x20 x 6



MODELLI DISPONIBILI

Articolo	Descrizione	Alimentazione
HB60	con pompa manuale	/
HB60M	con pompa elettrica	Monofase
HB60T	con pompa elettrica	Trifase

MODELS AVAILABLE

Article	Description	Tension
HB60	manual pump	/
HB60M	electric pump	Single phase
HB60T	electric pump	Three phase

CARATTERISTICHE

- Elevata potenza con un design compatto
- Utile anche dove non c'è elettricità (HB60)
- Macchina completamente idraulica
- Raggiunge l'angolo di curvatura di 210° in un unico passaggio
- Sistema di controllo meccanico
- Brevetto depositato
- Macchina composta in due parti
- Robusto corpo in alluminio

FEATURES

- High power with a compact design
- Useful even where there is no electricity (manual version)
- Completely Hydraulic machine
- It reaches the bending angle of 210° in a single step
- No electronic control systems
- Ercolina Patent Pending
- Machine composed in two parts
- Aluminum body



DATI TECNICI / TECHNICAL DATA

Modulo di Flessione Flexion Modulus	10 cm ³
Min Diametro Esterno Min. outside diameter	5 mm
Raggio Max. di Curvatura (CLR) Max bending radius (CLR)	270 mm
Raggio Min. di Curvatura (CLR) Min bending radius (CLR)	10 mm
Pompa manuale (M) Manual pump (M)	min. 25 cicli x 90°
Pompa idraulica elettrica Electric hydraulic pump	1 x 230 V
Controllo dell'angolo di curvatura Control of the angle of bending	Ruota meccanica con gradi Mechanical wheel with degrees
Larghezza x lunghezza Width x length	470 x 610 mm 302 x 674 mm (M)
Altezza Height	1055 mm 243 mm (M)
Peso Weight	141 Kg 76 Kg (M)























DOTAZIONE DI SERIE

- Esagono da 50 e 40 mm
- Supporto per contromatrice
- Volantino
- Chiave esagonale da 6mm
- Grasso spray Ercolina
- Ingrassatore

STANDARD EQUIPMENT

- 50 and 40mm hex shafts
- Counterbending die support
- Handwheel
- 6mm allen wrench key
- Ercolina grease spray
- Pump for grease

MAXIMUM CAPACITY - (mm)

SEZ.	MATERIALE - MATERIAL	10 cm ³
	Tubo AnsiB36, 10 e API - Gas Tube	2" x3,91
	Tubo standard acciaio - Standard Steel Tube	60,3x4,5
	Tubo Mobilio - Forniture tube	60x2
	Acciaio ST35 (per oleod.) - Hydraulic Steel ST35	50x10
	Inox AISI 304-318 - Stainless Steel AISI 304-318	60,3x2,6
	Inox AISI 308 (per alim.) - Stainless Steel AISI 308	60,3x2,6
	Ottone ricotto - Soft Brass	60,3x12,5
	Alluminio curvabile - Hard Copper & Aluminium	60,3x5,4
	Rame ricotto - Soft Copper	60,3x11
	Tubo Conduit (TAZ) - Conduit Tube (TAZ)	60,3x3,25
	Mepla, Geberit e simili - Mepla, Geberit and similars	63x43
	Acciaio FE42 (EN: S275J0) - Mild Steel (EN: S275J0)	45
	Acciaio FE42 (EN:S275J0) - Mild Steel (EN: S275J0)	60x30
	Acciaio FE42 (EN:S275J0) - Mild Steel (EN: S275J0)	60x16
	Acciaio FE42 (EN:S275J0) - Mild Steel (EN: S275J0)	60x30
	Acciaio FE42 (EN:S275J0) - Mild Steel (EN: S275J0)	60x30x4
	Acciaio FE42 (EN:S275J0) - Mild Steel (EN: S275J0)	60x40x7
	Acciaio FE42:(EN:S275J0) - Mild Steel (EN: S275J0)	60x40x3
	Acciaio FE42 (EN:S275J0) - Mild Steel (EN: S275J0)	55x55x2,5
	Acciaio FE42 (EN:S275J0) - Mild Steel (EN: S275J0)	35x35
	Acciaio FE42 (EN:S275J0) - Mild Steel (EN: S275J0)	60x60x8
	Acciaio FE42 (EN:S275J0) - Mild Steel (EN: S275J0)	40x35 x 5



MODELLI DISPONIBILI

Articolo	Descrizione	Alimentazione
SB48 PM	SuperBender SB48M	Monofase
SB48 PT	SuperBender SB48T	Trifase

CARATTERISTICHE

- Capacità Tubo Standard Acciaio: 48 x 3,5 mm
- Capacità Tubo : 1" 1/2 x 3,68 mm
- Capacità Tubo Quadro (FE42): 40x40x3 mm
- Ampio raggio di curvatura: da R10 a R300 mm
- Controllo TCPLUS
- Sistema di controllo di sovraccarico con spie lampeggianti di segnalazione
- Possibilità di adattare (optional) un posizionatore a due assi (A40/P) per consentire la produzione in serie di curvaturei su piani differenti
- Sistema cambio utensili semplice e veloce (Brevetto Ercolina)
- Facile da spostare grazie alle ruote incorporate e alla maniglia retrattile
- Comando a pedale
- Doppia velocità

DOTAZIONE DI SERIE

- Esagono da 50 e 40 mm
- Supporto per contromatrice
- Volantino
- Chiave esagonale da 6mm
- Grasso spray Ercolina
- Ingrassatore

STANDARD EQUIPMENT

- 50 and 40mm hex shafts
- Counterbending die support
- Handwheel
- 6mm allen wrench key
- Ercolina grease spray
- Pump for grease



MATRICE CON ROTAZIONE DX E SX
FORMER L/R BENDING



MODELS AVAILABLE

Article	Description	Tension
SB48 PM	SuperBender SB48M	Single phase
SB48 PT	SuperBender SB48T	Three phase

FEATURES

- Mild steel tube capacity 48 x 3,5 mm
- 1 1/2" x 3,68 Gas inches capacity
- Square tube capacity 40 x 40 x 3 mm
- Maximum CLR 300 mm
- TCPLUS Control
- Overload control system with flashing warning lights
- Possibility to adapt (optional) a two-axis positioner (A40/P) to allow series production of bends in different planes
- Quick and easy tool change system (Ercolina Patent)
- Easy to move thanks to the built-in wheels and retractable handle
- Foot pedal control
- Two bending speed



DATI TECNICI / TECHNICAL DATA

Modulo di Flessione Flexion Modulus	6 cm ³
Min Diametro Esterno Min. outside diameter	5 mm
Raggio Max. di Curvatura (CLR) Max bending radius (CLR)	300 mm
Raggio Min. di Curvatura (CLR) Min bending radius (CLR)	10 mm
Potenza Installata Motor	1,5 kW
Tensione di alimentazione Voltage requirement	110-220-400 V 1-3PH / 50-60 Hz
Velocità di curvatura Bending speed	2 - 3 rpm
Dimensioni Dimensions	410 x 1000 x 570 mm
Peso Weight	110 Kg























kit macchina + utensili
(matrice e contromatrice)*machine kit + tooling
(former & counterbending die)*

Art.	Macchina Machine	Tubo/Tube	Ø	Matrici/Formers
SB48MK2D SB48TK2D	SB48M SB48T	Pollici gas Gas inches	2 x Ø	0 1/2" (21.30 mm), R46 0 3/4" (26.90 mm), R56 0 1" (33.70 mm), R67 0 1 1/4 (42.25 mm), R90 0 1 1/2 (48.25 mm), R100
SB48MK3D SB48TK3D	SB48M SB48T	Pollici gas Gas inches	3 x Ø	0 1/2" (21.30 mm), R67 0 3/4" (26.90 mm), R82 0 1" (33.70 mm), R112 0 1 1/4 (42.25 mm), R130 0 1 1/2 (48.25 mm), R150
SB48MKTZ SB48TKTZ	SB48M SB48T	TAZ	/	0 16, R46 0 20, R67 0 25, R82 0 32, R112 0 40, R130 0 50, R170 0 63, R230
SB48MKOD SB48TKOD	SB48M SB48T	Pollici OD OD inches	/	0 5/8" (15.88 mm), R46 0 7/8" (22.22 mm), R56 0 1" (28.40 mm), R67 0 1 1/4 (31.75 mm), R56 0 1 1/2 (38.10 mm), R100

*Matrici in ghisa, contromatrici in ottone

*Formers in cast iron, counterbending dies in brass

MAXIMUM CAPACITY - (mm)

SEZ.	MATERIALE - MATERIAL	6 cm ³
	Tubo AnsiB36, 10 e API - Gas Tube	1" 1/2 x3.68
	Tubo standard acciaio - Standard Steel Tube	48x3,5
	Tubo Mobilio - Forniture tube	54x1,5
	Acciaio ST35 (per oleod.) - Hydraulic Steel ST35	50x4
	Inox AISI 304-318 - Stainless Steel AISI 304-318	48x2
	Inox AISI 308 (per alim.) - Stainless Steel AISI 308	48x2
	Ottone ricotto - Soft Brass	60x3
	Alluminio curvabile - Hard Copper & Aluminium	64x2
	Rame ricotto - Soft Copper	64x2
	Tubo Conduit (TAZ) - Conduit Tube (TAZ)	60x2
	Mepla, Geberit e simili - Mepla, Geberit and similars	50x4
	Acciaio FE42 (EN: S275J0) - Mild Steel (EN: S275J0)	32
	Acciaio FE42 (EN:S275J0) - Mild Steel (EN: S275J0)	8x48
	Acciaio FE42 (EN:S275J0) - Mild Steel (EN: S275J0)	45x16
	Acciaio FE42 (EN:S275J0) - Mild Steel (EN: S275J0)	45x25
	Acciaio FE42 (EN:S275J0) - Mild Steel (EN: S275J0)	50x25x3
	Acciaio FE42 (EN:S275J0) - Mild Steel (EN: S275J0)	50x30x5
	Acciaio FE42:(EN:S275J0) - Mild Steel (EN: S275J0)	20x40 x 3
	Acciaio FE42 (EN:S275J0) - Mild Steel (EN: S275J0)	40x40 x 3
	Acciaio FE42 (EN:S275J0) - Mild Steel (EN: S275J0)	30x30
	Acciaio FE42 (EN:S275J0) - Mild Steel (EN: S275J0)	40x40 x 5
	Acciaio FE42 (EN:S275J0) - Mild Steel (EN: S275J0)	32x16 x 5



MODELLI DISPONIBILI

Articolo	Descrizione	Alimentazione
SB48EDT PLUS	con inverter	Monofase

MODELS AVAILABLE

Article	Description	Tension
SB48EDT PLUS	with inverter	Single phase

CARATTERISTICHE

- Intuitivo Controllo EDT PLUS
- Ampio raggio di curvatura: da R10 a R300 mm
- Schermo ad alta risoluzione da 4,3"
- Programmazione multilingua
- Programmazione angolo di curvatura con inserimento del valore della compensazione del ritorno elastico
- Visualizzazione della percentuale di carico in fase di curvatura
- Rapido cambio Utensili
- Inverter
- Predisposizione per installazione dell'accessorio posizionatore oscillante su due assi A40-P, idoneo a realizzare curve in sequenza, garantendone la ripetibilità
- Comando a pedale
- Doppia velocità

FEATURES

- Intuitive EDT PLUS Control
- Maximum CLR 300 mm
- 4.3 "high resolution screen
- Multilingual
- Programming the bend angle and the value of the springback compensation
- Display of the percentage of load during bending
- Quick tooling change
- Inverter
- Possibility to mount the oscillating positioner accessory on two axes A40-P, suitable for making bends in sequence, ensuring repeatability
- Foot pedal control
- Two bending speed

DOTAZIONE DI SERIE

- Esagono da 50 e 40 mm
- Supporto per contromatrice
- Volantino
- Chiave esagonale da 6mm
- Grasso spray Ercolina
- Ingrassatore

STANDARD EQUIPMENT

- 50 and 40mm hex shafts
- Counterbending die support
- Handwheel
- 6mm allen wrench key
- Ercolina grease spray
- Pump for grease



CONTROLLO EDT PLUS

MATRICE CON ROTAZIONE DX E SX
FORMER L/R BENDING

DATI TECNICI / TECHNICAL DATA

Modulo di Flessione Flexion Modulus	6 cm ³
Min Diametro Esterno Min. outside diameter	5 mm
Raggio Max. di Curvatura (CLR) Max bending radius (CLR)	300 mm
Raggio Min. di Curvatura (CLR) Min bending radius (CLR)	10 mm
Potenza Installata Motor	1,5 kW
Tensione di alimentazione Voltage requirement	110-220-400 V 1-3PH / 50-60 Hz
Velocità di curvatura Bending speed	2 - 3 rpm
Dimensioni Dimensions	410 x 1000 x 570 mm
Peso Weight	110 Kg

kit macchina + utensili (matrice e contromatrice)*

machine kit + tooling (former & counterbending die)*

Art.	MACCHINA	TUBO	RAGGIO	MATRICI
SB48MK2D SB48TK2D	SB48M SB48T	Pollici gas Gas inches	2 x Ø	0 1/2" (21.30 mm), R46 0 3/4" (26.90 mm), R56 0 1" (33.70 mm), R67 0 1" 1/4 (42.25 mm), R90 0 1" 1/2 (48.25 mm), R100
SB48MK3D SB48TK3D	SB48M SB48T	Pollici gas Gas inches	3 x Ø	0 1/2" (21.30 mm), R67 0 3/4" (26.90 mm), R82 0 1" (33.70 mm), R112 0 1" 1/4 (42.25 mm), R130 0 1" 1/2 (48.25 mm), R150
SB48MKTZ SB48TKTZ	SB48M SB48T	TAZ	/	0 16, R46 0 20, R67 0 25, R82 0 32, R112 0 40, R130 0 50, R170 0 63, R230
SB48MKOD SB48TKOD	SB48M SB48T	Pollici OD OD inches	/	0 5/8" (15.88 mm), R46 0 7/8" (22.22 mm), R56 0 1" (28.40 mm), R67 0 1" 1/4 (31.75 mm), R56 0 1" 1/2 (38.10 mm), R100

*Matrici in ghisa, contromatrici in ottone

*Formers in cast iron, counterbending dies in brass

MAXIMUM CAPACITY - (mm)

SEZ.	MATERIALE - MATERIAL	6 cm ³
	Tubo AnsiB36, 10 e API - Gas Tube	1" 1/2 x3.68
	Tubo standard acciaio - Standard Steel Tube	48x3,5
	Tubo Mobilio - Forniture tube	54x1,5
	Acciaio ST35 (per oleod.) - Hydraulic Steel ST35	50x4
	Inox AISI 304-318 - Stainless Steel AISI 304-318	48x2
	Inox AISI 308 (per alim.) - Stainless Steel AISI 308	48x2
	Ottone ricotto - Soft Brass	60x3
	Alluminio curvabile - Hard Copper & Aluminium	64x2
	Rame ricotto - Soft Copper	64x2
	Tubo Conduit (TAZ) - Conduit Tube (TAZ)	60x2
	Mepla, Geberit e simili - Mepla, Geberit and similars	50x4
	Acciaio FE42 (EN: S275J0) - Mild Steel (EN: S275J0)	32
	Acciaio FE42 (EN:S275J0) - Mild Steel (EN: S275J0)	8x48
	Acciaio FE42 (EN:S275J0) - Mild Steel (EN: S275J0)	45x16
	Acciaio FE42 (EN:S275J0) - Mild Steel (EN: S275J0)	45x25
	Acciaio FE42 (EN:S275J0) - Mild Steel (EN: S275J0)	50x25x3
	Acciaio FE42 (EN:S275J0) - Mild Steel (EN: S275J0)	50x30x5
	Acciaio FE42:(EN:S275J0) - Mild Steel (EN: S275J0)	20x40 x 3
	Acciaio FE42 (EN:S275J0) - Mild Steel (EN: S275J0)	40x40 x 3
	Acciaio FE42 (EN:S275J0) - Mild Steel (EN: S275J0)	30x30
	Acciaio FE42 (EN:S275J0) - Mild Steel (EN: S275J0)	40x40 x 5
	Acciaio FE42 (EN:S275J0) - Mild Steel (EN: S275J0)	32x16 x 5

MODELLI DISPONIBILI

Articolo	Descrizione	Alimentazione
MB42M	MediBender MB42M	Monofase
MB42PT	MediBender MB42T	Trifase
MB42PM	Portatile	Monofase

MODELS AVAILABLE

Article	Description	Tension
MB42M	MediBender MB42M	Single phase
MB42PT	MediBender MB42M	Three phase
MB42PM	Portable	Single phase

CARATTERISTICHE

- Controllo TCPLUS (MB42PT)
- Asse C di curvatura elettromeccanico con visualizzazione digitale valori
- Controllo micrometrico con visualizzazione di posizione dell'asse X
- Capacità di programmare e memorizzare 30 programmi da 9 curve ciascuno comprende l'angolo di recupero (relativo all'elasticità del materiale)
- Singola velocità di curvatura
- Sistema di controllo di sovraccarico con spie lampeggianti di segnalazione
- Disponibile con motore trifase e monofase
- Possibilità di adattare (optional) un posizionatore a due assi (A40/P) per consentire la produzione in serie di curvaturei su piani differenti
- Sistema cambio utensili semplice e veloce (Brevetto Ercolina)
- Facile da spostare grazie alle ruote incorporate e alla maniglia retrattile.
- Comando a pedale

FEATURES

- TCPLUS Control (MB42PT)
- Electromechanical bend axis (C) with digital visualization of the value
- Micrometric control on display of the X axis position
- Possibility to store up to 30 programs and for each program 9 bend angles with relative springback value
- One bending speed
- Overload control system with flashing warning lights
- Machine available in single - and three phase
- Optionally it is possible to mount a two axis positioning device (A40/P) to allow the serial production on different planes
- Quick tooling change system (Ercolina Patent)
- Easy to move thanks to the wheels and retractable handle
- Foot pedal control

DOTAZIONE DI SERIE

- Esagono da 40 mm
- Supporto per contromatrice
- Volantino
- Chiave esagonale da 6mm
- Grasso spray Ercolina
- Ingrassatore

STANDARD EQUIPMENT

- 40mm hex shafts
- Counterbending die support
- Handwheel
- 6mm allen wrench key
- Ercolina grease spray
- Pump for grease



MATRICE CON ROTAZIONE DX E SX
FORMER L/R BENDING



MEDI BENDER
MB42PT



MEDI BENDER
MB42PM

DATI TECNICI / TECHNICAL DATA

Modulo di Flessione Flexion Modulus	4 cm ³
Min Diametro Esterno Min. outside diameter	5 mm
Raggio Max. di Curvatura (CLR) Max bending radius (CLR)	260 mm
Raggio Min. di Curvatura (CLR) Min bending radius (CLR)	10 mm
Potenza Installata Motor	1,5 kW
Tensione di alimentazione Voltage requirement	220-400 V 1-3PH / 50-60 Hz
Velocità di curvatura Bending speed	1,64 rpm
Dimensioni Dimensions	400 x 1000 x 570 mm 400 x 450 x 570 mm (PM)
Peso Weight	80 Kg 50 Kg (PM)

**kit macchina + utensili
(matrice e contromatrice)***

**machine kit + tooling
(former & counterbending die)***

Art.	Macchina Machine	Tubo/Tube	Ø	Matrici/Formers
MB42MK2D MB42TK2D MB42PMK2D	MB42M MB42T MB42PM	Pollici gas Gas inches	2 x Ø	Ø 1/2" (21.30 mm), R46 Ø 3/4" (26.90 mm), R56 Ø 1" (33.70 mm), R67 Ø 1" 1/4 (42.25 mm), R90
MB42MK3D MB42TK3D MB42PMK3D	MB42M MB42T MB42PM	Pollici gas Gas inches	3 x Ø	Ø 1/2" (21.30 mm), R67 Ø 3/4" (26.90 mm), R82 Ø 1" (33.70 mm), R112 Ø 1" 1/4 (42.25 mm), R130
MB42MKTZ MB42TKTZ MB42PMKTZ	MB42M MB42T MB42PM	TAZ	/	Ø 16, R46 Ø 20, R67 Ø 25, R82 Ø 32, R112 Ø 40, R130 Ø 50, R170
MB42MKOD MB42TKOD MB42PMKOD	MB42M MB42T MB42PM	Pollici OD OD inches	/	Ø 5/8" (15.88 mm), R46 Ø 7/8" (22.22 mm), R56 Ø 1" (28.40 mm), R67 Ø 1" 1/4 (31.75 mm), R56

*Matrici in ghisa, contromatrici in ottone

*Formers in cast iron, counterbending dies in brass

MAXIMUM CAPACITY - (mm)

SEZ.	MATERIALE - MATERIAL	4 cm ³
	Tubo AnsiB36, 10 e API - Gas Tube	1"1/4 x 3,56
	Tubo standard acciaio - Standard Steel Tube	42x3
	Tubo Mobilio - Forniture tube	48x1,5
	Acciaio ST35 (per oleod.) - Hydraulic Steel ST35	42x4
	Inox AISI 304-318 - Stainless Steel AISI 304-318	42x2
	Inox AISI 308 (per alim.) - Stainless Steel AISI 308	42x2
	Ottone ricotto - Soft Brass	50x3
	Alluminio curvabile - Hard Copper & Aluminium	54x2
	Rame ricotto - Soft Copper	54x2
	Tubo Conduit (TAZ) - Conduit Tube (TAZ)	60x2
	Mepla, Geberit e simili - Mepla, Geberit and similars	50x4
	Acciaio FE42 (EN: S275J0) - Mild Steel (EN: S275J0)	30
	Acciaio FE42 (EN:S275J0) - Mild Steel (EN: S275J0)	7x42
	Acciaio FE42 (EN:S275J0) - Mild Steel (EN: S275J0)	40x12
	Acciaio FE42 (EN:S275J0) - Mild Steel (EN: S275J0)	40 x 20
	Acciaio FE42 (EN:S275J0) - Mild Steel (EN: S275J0)	40x20x2,6
	Acciaio FE42 (EN:S275J0) - Mild Steel (EN: S275J0)	40x20x2,6
	Acciaio FE42:(EN:S275J0) - Mild Steel (EN: S275J0)	18x35 x 2
	Acciaio FE42 (EN:S275J0) - Mild Steel (EN: S275J0)	35x35 x 3
	Acciaio FE42 (EN:S275J0) - Mild Steel (EN: S275J0)	25x25
	Acciaio FE42 (EN:S275J0) - Mild Steel (EN: S275J0)	35x35 x 5
	Acciaio FE42 (EN:S275J0) - Mild Steel (EN: S275J0)	28x14 x 5



MODELLI DISPONIBILI

Articolo	Descrizione	Alimentazione
MB42EDTP-M	con controllo EDT Plus	Monofase
MB42EDTP-T	con controllo EDT Plus	Trifase

CARATTERISTICHE

- Intuitivo Controllo EDT PLUS
- Schermo ad alta risoluzione da 4,3"
- Programmazione multilingua
- Programmazione angolo di curvatura con inserimento del valore della compensazione del ritorno elastico
- Visualizzazione della percentuale di carico in fase di curvatura
- Rapido cambio Utensili
- Inverter
- Predisposizione per installazione dell'accessorio posizionatore oscillante su due assi A40-P, idoneo a realizzare curve in sequenza, garantendone la ripetibilità
- Comando a pedale

DOTAZIONE DI SERIE

- Esagono da 40 mm
- Supporto per contromatrice
- Volantino
- Chiave esagonale da 6mm
- Grasso spray Ercolina
- Ingrassatore

STANDARD EQUIPMENT

- 40mm hex shafts
- Counterbending die support
- Handwheel
- 6mm allen wrench key
- Ercolina grease spray
- Pump for grease



CONTROLLO EDT PLUS

MATRICE CON ROTAZIONE DX E SX
FORMER L/R BENDING

MODELS AVAILABLE

Article	Description	Tension
MB42EDTP-M	EDT Plus control	Single phase
MB42EDTP-T	EDT Plus control	Three phase

FEATURES

- Intuitive EDT PLUS Control
- 4.3 "high resolution screen
- Multilingual
- Programming the bend angle and the value of the springback compensation
- Display of the percentage of load during bending
- Quick tooling change
- Inverter
- Possibility to mount the oscillating positioner accessory on two axes A40-P, suitable for making bends in sequence, ensuring repeatability
- Foot pedal control



DATI TECNICI / TECHNICAL DATA

Modulo di Flessione Flexion Modulus	4 cm ³
Min Diametro Esterno Min. outside diameter	5 mm
Raggio Max. di Curvatura (CLR) Max bending radius (CLR)	260 mm
Raggio Min. di Curvatura (CLR) Min bending radius (CLR)	10 mm
Potenza Installata Motor	1,5 kW
Tensione di alimentazione Voltage requirement	220-400 V 1-3PH / 50-60 Hz
Velocità di curvatura Bending speed	1,64 rpm
Dimensioni Dimensions	400 x 1000 x 570 mm
Peso Weight	80 Kg

kit macchina + utensili (matrice e contromatrice)*

machine kit + tooling (former & counterbending die)*

Art.	Macchina Machine	Tubo/Tube	Ø	Matrici/Formers
MB42MK2D MB42TK2D MB42PMK2D	MB42M MB42T MB42PM	Pollici gas Gas inches	2 x Ø	Ø 1/2" (21.30 mm), R46 Ø 3/4" (26.90 mm), R56 Ø 1" (33.70 mm), R67 Ø 1 1/4 (42.25 mm), R90
MB42MK3D MB42TK3D MB42PMK3D	MB42M MB42T MB42PM	Pollici gas Gas inches	3 x Ø	Ø 1/2" (21.30 mm), R67 Ø 3/4" (26.90 mm), R82 Ø 1" (33.70 mm), R112 Ø 1 1/4 (42.25 mm), R130
MB42MKTZ MB42TKTZ MB42PMKTZ	MB42M MB42T MB42PM	TAZ	/	Ø 16, R46 Ø 20, R67 Ø 25, R82 Ø 32, R112 Ø 40, R130 Ø 50, R170
MB42MKOD MB42TKOD MB42PMKOD	MB42M MB42T MB42PM	Pollici OD OD inches	/	Ø 5/8" (15.88 mm), R46 Ø 7/8" (22.22 mm), R56 Ø 1" (28.40 mm), R67 Ø 1 1/4 (31.75 mm), R56

*Matrici in ghisa, contromatrici in ottone

*Formers in cast iron, counterbending dies in brass

MAXIMUM CAPACITY - (mm)

SEZ.	MATERIALE - MATERIAL	4 cm ³
	Tubo AnsiB36, 10 e API - Gas Tube	1"1/4 x 3,56
	Tubo standard acciaio - Standard Steel Tube	42x3
	Tubo Mobilio - Forniture tube	48x1,5
	Acciaio ST35 (per oleod.) - Hydraulic Steel ST35	42x4
	Inox AISI 304-318 - Stainless Steel AISI 304-318	42x3
	Inox AISI 308 (per alim.) - Stainless Steel AISI 308	42x2,5
	Ottone ricotto - Soft Brass	50x3
	Alluminio curvabile - Hard Copper & Aluminium	54x2
	Rame ricotto - Soft Copper	60x2
	Tubo Conduit (TAZ) - Conduit Tube (TAZ)	60x2
	Mepla, Geberit e simili - Mepla, Geberit and similars	50x4
	Acciaio FE42 (EN: S275J0) - Mild Steel (EN: S275J0)	30
	Acciaio FE42 (EN:S275J0) - Mild Steel (EN: S275J0)	7x42
	Acciaio FE42 (EN:S275J0) - Mild Steel (EN: S275J0)	40x12
	Acciaio FE42 (EN:S275J0) - Mild Steel (EN: S275J0)	40 x 20
	Acciaio FE42 (EN:S275J0) - Mild Steel (EN: S275J0)	40x20x2,6
	Acciaio FE42 (EN:S275J0) - Mild Steel (EN: S275J0)	40x20x2,6
	Acciaio FE42:(EN:S275J0) - Mild Steel (EN: S275J0)	18x35 x 2
	Acciaio FE42 (EN:S275J0) - Mild Steel (EN: S275J0)	35x35 x 3
	Acciaio FE42 (EN:S275J0) - Mild Steel (EN: S275J0)	25x25
	Acciaio FE42 (EN:S275J0) - Mild Steel (EN: S275J0)	35x35 x 5
	Acciaio FE42 (EN:S275J0) - Mild Steel (EN: S275J0)	28x14 x 5



MODELLI DISPONIBILI		
Articolo	Descrizione	Alimentazione
MD070M	Medibender MD070M	Monofase

MODELS AVAILABLE		
Article	Description	Tension
MD070M	Medibender MD070M	Single phase

MODELLO SPECIALE - SPECIAL MODEL

ART:
MD071M

Modello più veloce con le stesse caratteristiche dell'art. MD070M.
Comando a pedale (art. P050H) non incluso.
Utilizzato per raggio di curvatura < 36 mm.

Faster model with same features as art. MD070M.
Foot swith control (art. P050H) not included.
Used for bending radius < 36 mm.

CARATTERISTICHE

- Raggio di curvatura: da R36 (10 per il modello MD 071M) a R190 mm
- Regolazione digitale dell'angolo di curvatura da 0° a 180°
- Sistema di controllo di sovraccarico
- Sistema cambio utensili semplice e veloce (Brevetto Ercolina)
- Base predisposta per fissaggio su cavalletto
- Custodia in metallo e un treppiede (opzionale)
- Comando a pedale
- Disponibile modello più veloce per raggi di curvatura < 36 mm

FEATURES

- Maximum radius from 36mm (10mm for the model MD071) to R190mm
- Bending angle digital setting from 0 to 180°
- Overload control system
- Quick-change tooling system (Ercolina Patent)
- Base prepared for fixing on tripod
- Metal case and tripod available (optional)
- Foot pedal control
- Faster model available for bending radius < 36 mm



Art. 084D1
optional



DATI TECNICI / TECHNICAL DATA

Modulo di Flessione Flexion Modulus	1,9 cm ³
Min Diametro Esterno Min. outside diameter	5 mm
Raggio Max. di Curvatura (CLR) Max bending radius (CLR)	190 mm
Raggio Min. di Curvatura (CLR) Min bending radius (CLR)	36 mm
Potenza Installata Motor	900 W
Tensione di alimentazione Voltage requirement	110-220 V 1PH
Velocità di curvatura Bending speed	2,8 rpm
Dimensioni Dimensions	245 x 300 x 320 mm
Peso Weight	23 Kg

DOTAZIONE DI SERIE

- Supporto per contromatrice
- Volantino
- Comando a pedale
- Grasso spray Ercolina
- Ingrassatore

STANDARD EQUIPMENT

- Counterbending die support
- Handwheel
- Foot pedal control
- Ercolina grease spray
- Pump for grease























kit macchina + utensili
(matrice e contromatrice)*machine kit + tooling
(former & counterbending die)*

Art.	Macchina Machine	Tubo/Tube	Matrici/Formers
MD070MKGS	MD070M	Pollici gas Gas inches	0 1/2" (21.30 mm), R46 0 3/4" (26.90 mm), R56 0 1" (33.70 mm), R82
MD070MKTZ	MD070M	TAZ	0 16, R46 0 20, R67 0 25, R82 0 32, R112 0 40, R130
MD070MKOD	MD070M	Pollici OD OD inches	0 5/8" (15.88 mm), R46 0 7/8" (22.22 mm), R56 0 1" (28.40 mm), R67

*Matrici in ghisa, contromatrici in ottone

*Formers in cast iron, counterbending dies in brass

MAXIMUM CAPACITY - (mm)

SEZ.	MATERIALE - MATERIAL	1.9 cm ³
	Tubo AnsiB36, 10 e API - Gas Tube	1" x 3,38
	Tubo standard acciaio - Standard Steel Tube	38x1,5
	Tubo Mobilio - Forniture tube	38x1,5
	Acciaio ST35 (per oleod.) - Hydraulic Steel ST35	35x3
	Inox AISI 304-318 - Stainless Steel AISI 304-318	30x2
	Inox AISI 308 (per alim.) - Stainless Steel AISI 308	35x1,5
	Ottone ricotto - Soft Brass	42x1,5
	Alluminio curvabile - Hard Copper & Aluminium	42x1,5
	Rame ricotto - Soft Copper	50x2
	Tubo Conduit (TAZ) - Conduit Tube (TAZ)	50x2
	Mepla, Geberit e simili - Mepla, Geberit and similars	50x4
	Acciaio FE42 (EN: S275J0) - Mild Steel (EN: S275J0)	20
	Acciaio FE42 (EN:S275J0) - Mild Steel (EN: S275J0)	10x25
	Acciaio FE42 (EN:S275J0) - Mild Steel (EN: S275J0)	25x16
	Acciaio FE42 (EN:S275J0) - Mild Steel (EN: S275J0)	25x20
	Acciaio FE42 (EN:S275J0) - Mild Steel (EN: S275J0)	/
	Acciaio FE42 (EN:S275J0) - Mild Steel (EN: S275J0)	/
	Acciaio FE42 (EN:S275J0) - Mild Steel (EN: S275J0)	15x25 x 3
	Acciaio FE42 (EN:S275J0) - Mild Steel (EN: S275J0)	25x25 x 3
	Acciaio FE42 (EN:S275J0) - Mild Steel (EN: S275J0)	20x20
	Acciaio FE42 (EN:S275J0) - Mild Steel (EN: S275J0)	30x30 x 5
	Acciaio FE42 (EN:S275J0) - Mild Steel (EN: S275J0)	30x15 x 5



MODELLI DISPONIBILI

Articolo	Descrizione	Alimentazione
MD083	Manuale	/

MODELS AVAILABLE

Article	Description	Tension
MD083	Manual	/

CARATTERISTICHE

- Capacità Tubo Standard Acciaio: 35 x 2,5 mm
- Capacità Tubo: 1" x 3,4 mm
- Capacità Tubolare Quadro (FE42): 25x25x3 mm
- Raggio di curvatura: da R36 a R190 mm
- Macchina manuale
- Disco graduato per la misurazione dell'angolo di curvatura
- Sistema cambio utensili semplice e veloce (Brevetto Ercolina)
- Base predisposta per fissaggio su cavalletto
- Nessun componente idraulico o elettrico
- Con accessori opzionali può essere attivata da trapano elettrico

FEATURES

- Standard steel tube capacity 35 x 2.5 mm
- Pipe capacity 1" Sch. 10
- Square tube capacity 25 x 25 x 3 mm
- Bending radius 36 ÷ 190 mm
- Manual machine
- Graduated disc for measuring the angle of bending
- Quick and easy tool change system (Ercolina Patent)
- Base prepared for fixing on easel
- No hydraulic or electric components
- With optional accessories can be activated by electric drill



Disco graduato per la misurazione dell'angolo di curvatura
Graduated disc for measuring the bending angle



DATI TECNICI / TECHNICAL DATA

Modulo di Flessione Flexion Modulus	1,9 cm ³
Min Diametro Esterno Min. outside diameter	5 mm
Raggio Max. di Curvatura (CLR) Max bending radius (CLR)	190 mm
Raggio Min. di Curvatura (CLR) Min bending radius (CLR)	36 mm
Potenza Installata Motor	/
Tensione di alimentazione Voltage requirement	/
Velocità di curvatura Bending speed	/
Dimensioni Dimensions	245 x 200 x 320 mm
Peso Weight	17 Kg

DOTAZIONE DI SERIE

- Supporto per contromatrice
- Volantino
- Comando a pedale
- Grasso spray Ercolina
- Ingrassatore

STANDARD EQUIPMENT

- Counterbending die support
- Handwheel
- Foot pedal control
- Ercolina grease spray
- Pump for grease























kit macchina + utensili
(matrice e contromatrice)*machine kit + tooling
(former & counterbending die)*

Art.	Macchina Machine	Tubo/Tube	Matrici/Formers
MD083KMM	MD083	Millimetri Millimeters	Ø 12, R36 Ø 14, R40 Ø 16, R46 Ø 18, R56 Ø 22, R67 Ø 28, R96
MD083KTZ	MD083	TAZ	Ø 16, R46 Ø 20, R67 Ø 25, R82 Ø 32, R112 Ø 40, R130

*Matrici in ghisa, contromatrici in ottone

*Formers in cast iron, counterbending dies in brass

MAXIMUM CAPACITY - (mm)

SEZ.	MATERIALE - MATERIAL	1.9 cm ³
	Tubo AnsiB36, 10 e API - Gas Tube	1" x 3,38
	Tubo standard acciaio - Standard Steel Tube	38x1,5
	Tubo Mobilio - Forniture tube	38x1,5
	Acciaio ST35 (per oleod.) - Hydraulic Steel ST35	35x3
	Inox AISI 304-318 - Stainless Steel AISI 304-318	30x2
	Inox AISI 308 (per alim.) - Stainless Steel AISI 308	35x1,5
	Ottone ricotto - Soft Brass	42x1,5
	Alluminio curvabile - Hard Copper & Aluminium	42x1,5
	Rame ricotto - Soft Copper	50x2
	Tubo Conduit (TAZ) - Conduit Tube (TAZ)	50x2
	Mepla, Geberit e simili - Mepla, Geberit and similars	50x4
	Acciaio FE42 (EN: S275J0) - Mild Steel (EN: S275J0)	20
	Acciaio FE42 (EN:S275J0) - Mild Steel (EN: S275J0)	10x25
	Acciaio FE42 (EN:S275J0) - Mild Steel (EN: S275J0)	25x16
	Acciaio FE42 (EN:S275J0) - Mild Steel (EN: S275J0)	25x20
	Acciaio FE42 (EN:S275J0) - Mild Steel (EN: S275J0)	/
	Acciaio FE42 (EN:S275J0) - Mild Steel (EN: S275J0)	/
	Acciaio FE42:(EN:S275J0) - Mild Steel (EN: S275J0)	15x25 x 3
	Acciaio FE42 (EN:S275J0) - Mild Steel (EN: S275J0)	25x25 x 3
	Acciaio FE42 (EN:S275J0) - Mild Steel (EN: S275J0)	20x20
	Acciaio FE42 (EN:S275J0) - Mild Steel (EN: S275J0)	30x30 x 5
	Acciaio FE42 (EN:S275J0) - Mild Steel (EN: S275J0)	30x15 x 5



MODELLI DISPONIBILI

Articolo	Descrizione	Alimentazione
MN092M	MiniBender MN092M	Monofase

MODELS AVAILABLE

Article	Description	Tension
MN092M	MiniBender MN092M	Single phase

CARATTERISTICHE

- Capacità Tubo Standard Acciaio: 27 x 2,3 mm
- Capacità Tubo: 3/4" x 2,9 mm
- Raggio di curvatura: da R36 a R190 mm
- Controllo semplice a microprocessore con display digitale dell'angolo di curvatura e l'angolo di ritorno
- Possibilità di programmare fino a tre angoli di curvatura con valori di recupero separati
- Modalità operativa addizionale a "curvatura libera".
- Angolo di curvatura monitorato con un quadrante di precisione
- Sistema di avanzamento a vite della contromatrice
- Sistema cambio utensili semplice e veloce (Brevetto Ercolina)
- Cavalletto di serie

FEATURES

- Standard steel tube capacity 27 x 2.3 mm
- Gas tube capacity 3/4" Gas x 2.9 mm
- Bending radius 36 ÷ 190 mm
- Simple microprocessor control with digital display for the angle of bending and the angle of return
- Possibility to program up to three bending angles with separate recovery values
- Additional operating mode at "free curvature"
- Curvature angle monitored with a precision dial
- Screw feed system of the counterbending die
- Quick and easy tool change system (Ercolina Patent)
- Standard easel

**Art. 084D1**

Cavalletto componibile - Tripod



DATI TECNICI / TECHNICAL DATA

Modulo di Flessione Flexion Modulus	0,7 cm ³
Min Diametro Esterno Min. outside diameter	5 mm
Raggio Max. di Curvatura (CLR) Max bending radius (CLR)	190 mm
Raggio Min. di Curvatura (CLR) Min bending radius (CLR)	36 mm
Potenza Installata Motor	800 W
Tensione di alimentazione Voltage requirement	110 - 220 V 1PH
Velocità di curvatura Bending speed	2 rpm
Dimensioni Dimensions	200 x 105 x 360 mm
Peso Weight	15 Kg

DOTAZIONE DI SERIE

- Staffa per contromatrici
- Cassetta in Metallo
- Cavalletto componibile
- Leva per staffa di supporto

STANDARD EQUIPMENT

- Counterbending die support
- Metal case
- Modular easel
- Lever for support bracket

kit macchina + utensili
(matrice e contromatrice)*























machine kit + tooling
(former & counterbending die)*

Art.	Macchina Machine	Tubo/Tube	Matrici/Formers
MN092MKMM	MN092	Millimetri Millimeters	Ø 12, R36
			Ø 14, R40
			Ø 16, R46
			Ø 18, R56
			Ø 22, R67
MN092MKME	MN092M	Millimetri Millimeters	Ø 28, R96
			Ø 15, R46
			Ø 18, R56
			Ø 22, R67
MN092MKMG	MN092M	Mepla, Geberit e simili Mepla, Geberit and similars	Ø 28, R96
			Ø 15, R46
			Ø 20, R67
			Ø 26, R82
			Ø 32, R112
MN092MKOD	MN092M	Pollici OD OD inches	Ø 40, R160
			Ø 50, R170
			Ø 1/2" (12.70 mm), R46
			Ø 3/4" (19.05 mm), R67
			Ø 1" (25.40 mm), R82
			Ø 1" 1/8 (28.58 mm), R112

*Matrici in ghisa, contromatrici in ottone

*Formers in cast iron, counterbending dies in brass

MAXIMUM CAPACITY - (mm)

SEZ.	MATERIALE - MATERIAL	0.7 cm ³
	Tubo AnsiB36, 10 e API - Gas Tube	3/4" x 2,87
	Tubo standard acciaio - Standard Steel Tube	27x2,3
	Tubo Mobilio - Forniture tube	28x2,5
	Acciaio ST35 (per oleod.) - Hydraulic Steel ST35	28x1,5
	Inox AISI 304-318 - Stainless Steel AISI 304-318	28x1,5
	Inox AISI 308 (per alim.) - Stainless Steel AISI 308	28x1,5
	Ottone ricotto - Soft Brass	28x2
	Alluminio curvabile - Hard Copper & Aluminium	28x1,5
	Rame ricotto - Soft Copper	35x1,3
	Tubo Conduit (TAZ) - Conduit Tube (TAZ)	42x2
	Mepla, Geberit e simili - Mepla, Geberit and similars	50x4
	Acciaio FE42 (EN: S275J0) - Mild Steel (EN: S275J0)	16
	Acciaio FE42 (EN:S275J0) - Mild Steel (EN: S275J0)	/
	Acciaio FE42 (EN:S275J0) - Mild Steel (EN: S275J0)	/
	Acciaio FE42 (EN:S275J0) - Mild Steel (EN: S275J0)	/
	Acciaio FE42 (EN:S275J0) - Mild Steel (EN: S275J0)	/
	Acciaio FE42 (EN:S275J0) - Mild Steel (EN: S275J0)	/
	Acciaio FE42 (EN:S275J0) - Mild Steel (EN: S275J0)	/
	Acciaio FE42 (EN:S275J0) - Mild Steel (EN: S275J0)	/
	Acciaio FE42 (EN:S275J0) - Mild Steel (EN: S275J0)	/
	Acciaio FE42 (EN:S275J0) - Mild Steel (EN: S275J0)	/
	Acciaio FE42 (EN:S275J0) - Mild Steel (EN: S275J0)	/



ALBERO ESAGONALE da 40 e da 50 mm
40 and 50 mm HEXAGONAL SHAFT



Art. P050A ●
Art. P050B ●

STAFFA PROLUNGATA di supporto per contromatrici
PROLONGED SUPPORT BRACKET for counterbending die



● Art. P050D/1

CURSORE UNIVERSALE
UNIVERSAL SLIDER



Art. P575/1 ●

VOLANTINO
HANDWHEEL



● Art. P050G

COMANDO A PEDALE
FOOT PEDAL CONTROL



Art. P050H ● Art. P050H1 (solo per TOP 050)

PROLUNGA PER CONTROMATRICI
EXTENSION FOR COUNTERBENDING DIE



■ Art. 152-P

CHIAVE ESAGONALE da 6 mm
6 mm HEXAGONAL KEY



Art. P0514A ●

GRASSO SPRAY SPECIALE e INGRASSATORE
SPECIAL GREASE SPRAY and PUMP FOR GREASE



Art. 810P ●

● Art. P010

Legenda: ● = di serie ■ = opzionale na = non applicabile

ALBERO PORTAUTENSILI SPECIALE SPECIAL TOOL SHAFT

Da utilizzare con matrice 157A per raggi di curvatura da 10 a 35 mm
For use with mandrel 157A for bending radius from 10 to 35 mm



Art. 050C ■

MATRICE SPECIALE SPECIAL FORMER

Con albero speciale per raggi da 10 a 35 mm
With special shaft for radius from 10 to 35 mm



Art. 050S ■

STAFFA SPECIALE SPECIAL BRACKET

Supporto per contromatrici. Disponibile per raggi di curvatura da 225 a 290
Support for counterbending die. Available for bending radius from 225 to 290



Art. P050E ■

PIASTRA SPECIALE CON ESTRATTORE SPECIAL PLATE WITH EXTRACTOR



Art. P500P1 ■

POSIZIONATORE OSCILLANTE DU DUE ASSI TWO AXIS OSCILLATING POSITIONER

Per curvature multiple per tubi max Ø 48 mm.
Lunghezze da 3 e da 6 mt; mandrino pneumatico; battute meccaniche per il posizionamento tubo; disponibile su richiesta il modello A40/PD con visualizzatore digitale di quota.

For multiple bends for tubes max Ø 48 mm.
Lengths from 3 and 6 mt; pneumatic chuck; mechanical stops for tube positioning; A40/PD model available on request with digital altitude display.



Art. A40/P ■

MATRICE DX E SX FORMER L/R



Art. P593 -DX-SX ■

Legend: ● = standard ■ = optional na = not applicable

DISPOSITIVO DI POSIZIONAMENTO su due assi per curvature multiple.
 Utilizzabile con matrici in acciaio e alluminio per raggi da 150 a 20 mm.
 TWO-AXIS LENGTH STOP DEVICE for multiple bends.
 Using with steel and aluminium formers, radius from 150 to 20 mm.



Art. 050M ■

BANCO ANIMA

A tre assi tridimensionali, ideale per curvare tubi di piccoli diametri e di ogni materiale con raggi stretti in piccoli lotti produttivi o per la realizzazione di prototipi. Disponibile con estrazione anima manuale o pneumatica.

MANDREL TABLE

3 tridimensional axis, ideal for small diameters, small radius and every material tube bending for few pieces lots, or prototypes. Available with manual or pneumatic mandrel extraction.

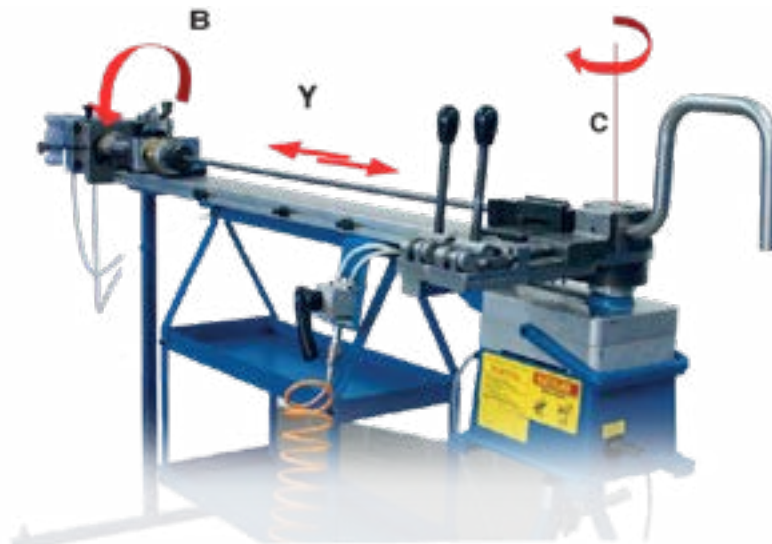

Art. A30M/1,5 ■
 (L. 1,5 mt, estr. anima manuale.
 Per tutte le macchine. Manual
 extrac. mandrel. For all the
 machines.

Art. A30P/1,5 ■
 (L. 1,5 mt, estr. anima
 pneumatica. Per tutte le
 macchine. Pneumatic extrac.
 mandrel. For all the machines.

Art. A30M/3 ■
 (L. 3 mt, estr. anima manuale.
 Per tutte le macchine. Manual
 extraction mandrel. For all the
 machines.

Art. A30P/3 ■
 (L. 3 mt, estr. anima
 pneumatica. Per tutte le
 macchine. Pneumatic extrac.
 mandrel. For all the machines.

Legenda: ● = di serie ■ = opzionale na = non applicabile

POSIZIONATORE OSCILLANTE SU DUE ASSI per curvature multiple per tubi dal diametro massimo di 48 mm; lunghezza da 3 a 6 mt compreso adattatore per applicazione.
 OSCILATING POSITIONER ON TWO AXES for multiple bending for tubes with a maximum diameter of 48 mm; length from 3 to 6 m including adapter for application.

Per curvature multiple per tubi max Ø 48 mm. Lunghezze da 3 e da 6 mt; mandrino pneumatico; battute meccaniche per il posizionamento tubo; disponibile su richiesta il modello A40/PD con visualizzatore digitale di quota.
 For multiple bends for tubes max Ø 48 mm. Lengths from 3 and 6 mt; pneumatic mandrel; mechanical stops for tube positioning; A40/PD model with digital dimension display available on request.



■ Art. A40/P-MB42

POSIZIONATORE A DUE ASSI (BREVETTATO)
 (il posizionario può essere con quote visualizzate o con pedale)
 TWO-AXIS POSITIONER (PATENTED)
 (the positioner can be with dimensions displayed or with pedal)



Art. A180/P Posizionatore a 2 assi x TB180 ■
 Two-axis positioner x TB180

■ Art. A100/P Posizionatore a 2 assi x TB80, TB100, TB130
 Two-axis positioner x TB80, TB100, TB130

Legend: ● = standard ■ = optional na = not applicable

ALBERO PORTAUTENSILI SPECIALE SPECIAL TOOL SHAFT

Da utilizzare con matrice 157A per raggi di curvatura da 10 a 35 mm
For use with mandrel 157A for bending radius from 10 to 35 mm



Art. 042C ■ MB42/P
na MD070 - MD083 - MN092

MATRICE SPECIALE SPECIAL FORMER

Con albero speciale per raggi da 10 a 35 mm
With special shaft for radius from 10 to 35 mm



MB42/P ■ Art. 042S
MD070 - MD083 - MN092 na

LEVA LEVER

Da utilizzare per l'inserimento in posizione della contromatrice
To be used for the insertion in position of the counterbending die



Art. P084F ● MD070 - MD071 - MD083 - MN092

STAFFA DI RINFORZO REINFORCING BRACKET

Da fissare su matrici in alluminio da R82 a R130
To be fixed on aluminium dies from R82 to R130



MD070 - MD083 ● Art. P084G
MB42/P - MN092 ■

DISPOSITIVO DI POSIZIONAMENTO per curvature multiple.
Utilizzabile con matrici in acciaio e alluminio per raggi da 150 a 250 mm.
TWO-AXIS LENGTH STOP DEVICE for multiple bends.
Using with steel and aluminium formers, radius from 150 to 250 mm.



Art. 050M ■

Legenda: ● = di serie ■ = opzionale na = non applicabile

GRASSO SPRAY SPECIALE e INGRASSATORE SPECIAL GREASE SPRAY and PUMP FOR GREASE



Art. 810P ●

● Art. P010

COMANDO A PEDALE FOOT PEDAL CONTROL



● Art. P050H

VOLANTINO HANDWHEEL



Art. MP027 ● MB42/P
na MD070 - MD083 - MN092

ALBERO PER MEDIBENDER SHAFT FOR MEDIBENDER



MB42/P ● Art. MP027
MD070 - MD083 - MN092 na

STAFFA PER MEDIBENDER BRACKET FOR MEDIBENDER



Art. MP019A ● MB42/P
na MD070 - MD083 - MN092

CURSORE UNIVERSALE UNIVERSAL SLIDER



MB42/P ● Art. MP018/1
MD070 - MD083 - MN092 na

Legend: ● = standard ■ = optional na = not applicable

STAFFA DI SUPPORTO PER CONTROMATRICI
SUPPORT BRACKET FOR COUNTERBENDING DIE

Art. 084E1 ● MD070 - MD083
na MB42/P - MN092

ALBERO PORTAUTENSILE SPECIALE
SPECIAL TOOL SHAFT

MB42/P ■ Art. 042C
MD070 - MD083 - MN092 na

CAVALLETTO COMPONENTE
MODULAR TRIPOD

Art. 084D1 ● MN092
■ MD070 - MD083
na MB42/P

POSIZIONATORE OSCILLANTE SU DUE ASSI
OSCILLATING POSITIONER ON TWO AXES

MB42/P ■ Art. A40/P - MB42
MD070 - MD083 - MN092 na

SVASATORE
REAMER

Art. 803 ■ MD070 - MD083 - MN092
na MB42/P

SVASATORE
REAMER

MD070 - MD083 - MN092 ■ Art. 802
MB42/P na

Legenda: ● = di serie ■ = opzionale na = non applicabile

CASSETTA IN METALLO METAL BOX



Art. R600 ● MN092

CASSETTA IN METALLO METAL BOX



MD070 ● Art. R500P
MD083 ■

ACCESSORIO PER LAVORAZIONE TUBO TUBE WORKING ACCESSORY



Art. 087 ■ MD070 - MD083
na MB42/P - MN092

MANOVELLA HANDLE



MD083 ● Art. P084L
MB42/P - MD070 - MN092 na

FRIZIONE A SLITTAMENTO TRANSMISSION UNIT



Art. 083A ■ MD083
na MB42/P - MD070 - MN092

SUPPORTO FERMAPUNTO DRILL HOLDER



MD083 ■ Art. 083B
MB42/P - MD070 - MN092 na

Legend: ● = standard ■ = optional na = not applicable

**CURSORE UNIVERSALE IN OTTONE
UNIVERSAL BRASS SLIDER**

Art. P149 ● MD070 - MD083
na MB42/P - MN092

**CURSORE
SLIDER**

MN092 ● Art. P811
MB42/P - MD070 - MD083 na

**STAFFA PER CONTROMATRICI
COUNTERBENDING DIE BRACKET**

Art. 092E1 ● MN092
na MB42/P - MD070 - MD083

**MATRICE DX E SX
FORMER L/R**

MB42 ■ Art. P593-DX-SX
MD070 - MD083 - MN092 na

Legenda: ● = di serie ■ = opzionale na = non applicabile

MATRICI SENZ'ANIMA - Guida alla scelta

Le macchine senza anima Ercolina sono equipaggiate con utensili che adottano la più avanzata tecnologia, sviluppata e affinata da un'esperienza trentennale di ricerca nei mercati internazionali.

Un set completo di utensili si compone di due parti principali, la MATRICE, che dà forma alla curva ruotando insieme all'asse di rotazione della macchina, e la CONTROMATRICE (o in casi particolari il rullo), che, adeguatamente posizionata, garantisce il bloccaggio del profilo nel moto reciproco durante la fase di curvatura. Per selezionare il set più adeguato di utensili, i parametri che entrano in gioco sono: tipo di materiale, dimensione del profilo (per tubi tondi il diametro esterno del profilo) ed il raggio desiderato (distanza tra centro curva e centro tubo).

Le tabelle esplicative di seguito vi guideranno nella selezione delle matrici.

Gli utensili per il modello TopBender TB180 sono realizzati in accordo alle specifiche del cliente.

L'ufficio tecnico è sempre disponibile a sviluppare soluzioni personalizzate per ogni esigenza di curvatura di tubi e profili vari.

MATRICI PER TB130, TB100, TB80

Serie articolo	Sezione	Utensili*	Descrizione
ABB	Tubo	Standard	<p>Materiale: Matrici in ghisa</p> <p>Ideale per creare: Tubi in acciaio ferroso ($R= 42\text{Kg}/\text{mm}^2$ - L.E. 250 N/mm^2), rame crudo e simili (con spessore inferiore a 3.6 mm)</p> <p>Dimensione tubi: Raggi e diametri disponibili standard. Spessori minimi: contattare i ns. uffici commerciali.</p>
ABB...R	Tubo	Semi-speciale	<p>Materiale: Matrici in ghisa</p> <p>Ideale per creare: Tubi in acciaio ferroso ($R= 42\text{Kg}/\text{mm}^2$ - L.E. 250 N/mm^2), rame crudo e simili (con spessore inferiore a 3.6 mm)</p> <p>Dimensione tubi: Raggi e diametri disponibili standard. Spessori minimi: contattare i ns. uffici commerciali.</p>
ABB_R	Tubo	Speciale	<p>Materiale: Matrici in acciaio</p> <p>Ideale per creare: Tubi in acciaio ferroso ($R= 42\text{Kg}/\text{mm}^2$ - L.E. 250 N/mm^2), rame crudo e simili (con spessore inferiore a 3.6 mm)</p> <p>Dimensione tubi: Raggi e diametri disponibili standard.</p>
DSM_R	Tubo	Speciale	<p>Materiale: Matrici in acciaio per curvare destra e sinistra</p> <p>Ideale per creare: Tubi in acciaio ferroso ($R= 42\text{Kg}/\text{mm}^2$ - L.E. 250 N/mm^2), rame crudo e simili (con spessore inferiore a 3.6 mm)</p> <p>Dimensione tubi: Raggi disponibili standard e diametri su richiesta.</p>

*Legenda Utensili: Standard = Raggio e diametro standard;
Semi-speciale = Raggio standard e diametro speciale;
Speciale = Raggio e diametro speciale.

NON MANDREL FORMERS - Guide to choosing

Ercolina non mandrel machines are supplied with the most advanced tooling technology, developed by thirty years international market experience and research.

A complete set of tools is made up of two main components, the FORMER, that shapes the curve turning round together with the machine rotating shaft, and the COUNTERBENDING DIE (or in particular cases the roll), that is moved towards the profile to block it during the bending phase.

To choose the most appropriate set of tooling, the main parameters are: type of material, profile dimensions (the outside diameters, for round tubes) and the required radius (distance in mm or inches, between the center of the bend and the tube center line).

The following selection tables will guide you through former choice.

The tools for the TopBender TB180 model are manufactured according to customer specifications.

The technical department is always available to develop customized solutions for every bending need of tubes and profiles.

FORMERS FOR TB130, TB100, TB80

Article Series	Section	Tools*	Description
ABBD	Tube	Standard	<p>Material: Cast iron formers</p> <p>Ideal for bending: Mild steel tubes (R= 42Kg/mm² - L.E. 250 N/mm²). hard copper and similars (with wall thickness smaller than 3.6 mm - 0.15")</p> <p>Tube dimension: Standard radius and diameters available. For minimum wall thickness contact our offices.</p>
ABBD...R	Tube	Semi-special	<p>Material: Cast iron formers</p> <p>Ideal for bending: Mild steel tubes (R= 42Kg/mm² - L.E. 250 N/mm²). hard copper and similars (with wall thickness smaller than 3.6 mm - 0.15")</p> <p>Tube dimension: Standard radius and diameters available. For minimum wall thickness contact our offices.</p>
ABBD_R	Tube	Special	<p>Material: Steel formers</p> <p>Ideal for bending: Mild steel tubes (R= 42Kg/mm² - L.E. 250 N/mm²). hard copper and similars (with wall thickness smaller than 3.6 mm - 0.15")</p> <p>Tube dimension: Standard radius and diameters available.</p>
DSMD_R	Tube	Special	<p>Material: Steel formers for left and right bending</p> <p>Ideal for bending: Mild steel tubes (R= 42Kg/mm² - L.E. 250 N/mm²). hard copper and similars (with wall thickness smaller than 3.6 mm - 0.15")</p> <p>Tube dimension: Standard radius available and diameters upon request.</p>

*Tools legend: Standard = Standard radius and diameter;
Semi-special = Standard radius and special diameter;
Special = Special radius and diameter.

Serie articolo	Sezione	Utensili*	Descrizione
151 153 153/1	Tubo	Standard	Materiale: Matrici in ghisa Ideale per creare: Tubi in acciaio ferroso (R= 42Kg/mm ² - L.E. 250 N/mm ²), rame crudo e simili (con spessore inferiore a 3.6 mm) Dimensione tubi: Raggi e diametri disponibili standard. Spessori minimi: consultare tabelle 1, 2, 3.
151L 153L 153/1L	Tubo	Standard	Materiale: Matrici serie leggera in ghisa Ideale per creare: Acciaio inox, materiali morbidi come alluminio (escluso rame); Applicazioni ornamentali (dove la presenza di segni sul tubo è ridotta al minimo) Applicazioni idrauliche (con spessore del profilo superiore a 3.6 mm e inferiore a 5 mm) Dimensione tubi: Raggi e diametri disponibili standard. Spessori minimi: consultare tabelle 1, 2, 3.
156	Tubo	Semi-speciale	Materiale: Matrici in ghisa Ideale per creare: Tubi in acciaio ferroso (R= 42Kg/mm ² - L.E. 250 N/mm ²), rame crudo e simili (con spessore inferiore a 3.6 mm) Dimensione tubi: Raggi disponibili standard e diametri su richiesta.
156L	Tubo	Semi-speciale	Materiale: Matrici serie leggera in ghisa Ideale per creare: Acciaio inox, materiali morbidi come alluminio (escluso rame); Applicazioni ornamentali (dove la presenza di segni sul tubo è ridotta al minimo) Applicazioni idrauliche (con spessore del profilo superiore a 3.6 mm e inferiore a 5 mm) Dimensione tubi: Raggi disponibili standard e diametri su richiesta.
157	Tubo	Speciale	Materiale: Matrici in ghisa e/o acciaio (il materiale è a discrezione dell'Azienda Costruttrice) Ideale per creare: Tubi in acciaio ferroso (R= 42Kg/mm ² - L.E. 250 N/mm ²), rame crudo e simili (con spessore inferiore a 3.6 mm) Dimensione tubi: Raggi e diametri su richiesta. Spessori minimi: consultare tabelle 4, 5, 6.
157L	Tubo	Speciale	Materiale: Matrici in ghisa e/o acciaio (il materiale è a discrezione dell'Azienda Costruttrice) Ideale per creare: Acciaio inox, materiali morbidi come alluminio (escluso rame); Applicazioni ornamentali (dove la presenza di segni sul tubo è ridotta al minimo) Dimensione tubi: Raggi e diametri su richiesta. Spessori minimi: consultare tabelle 4, 5, 6.
158	Tubo	Speciale	Materiale: Matrici in ghisa e/o acciaio (il materiale è a discrezione dell'Azienda Costruttrice) Ideale per creare: Profilati in acciaio ferroso (R= 42Kg/mm ² - L.E. 250 N/mm ²), acciaio inox e simili Dimensione tubi: Raggi e diametri su richiesta.

Articolo matrice

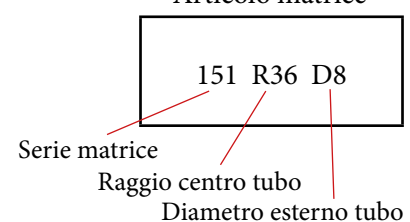

*Legenda Utensili: Standard = Raggio e diametro standard;
Semi-speciale = Raggio standard e diametro speciale;
Speciale = Raggio e diametro speciale.

Article Series	Section	Tools*	Description
151 153 153/1	Tube	Standard	Material: Cast iron formers Ideal for bending: Mild steel tubes (R= 42Kg/mm ² - L.E. 250 N/mm ²), hard copper and similars (with wall thickness smaller than 3.6 mm - 0.15") Tube dimension: Standard radius and diameters available. For minimum wall thickness see tables 1, 2, 3.
151L 153L 153/1L	Tube	Standard	Material: Cast iron light series formers Ideal for bending: Stainless steel, soft material such as aluminium (except copper); Ornamental applications (where marks and scratches need to be minimal); Hydraulic applications (with thicknesses higher than 3.6mm/0.15" and smaller than 5 mm/0.2"). Dimensione tubi: Standard radius and diameters available. For minimum wall thickness see tables 1, 2, 3.
156	Tube	Semi-special	Material: Cast iron formers Ideal for bending: Mild steel tubes (R= 42Kg/mm ² - L.E. 250 N/mm ²), hard copper and similars (with wall thickness smaller than 3.6 mm - 0.15") Tube dimension: Standard radius available. Diameters upon request.
156L	Tube	Semi-special	Material: Cast iron light series formers Ideal for bending: Stainless steel, soft material such as aluminium (except copper); Ornamental applications (where marks and scratches need to be minimal); Hydraulic applications (with thicknesses higher than 3.6mm/0.15" and smaller than 5 mm/0.2"). Dimensione tubi: Standard radius available. Diameters upon request.
157	Tube	Special	Material: Cast iron and/or steel formers (material at the discretion of the Company) Ideal for bending: Mild steel tubes (R= 42Kg/mm ² - L.E. 250 N/mm ²), hard copper and similars Tube dimension: Radius and diameters upon request. For minimum wall thickness see tables 4, 5, 6.
157L	Tube	Special	Material: Cast iron and/or steel formers (material at the discretion of the Company) Ideal for bending: Stainless steel, soft material such as aluminium (except copper); Ornamental applications (where marks and scratches need to be minimal). Dimensione tubi: Radius and diameters upon request. For minimum wall thickness see tables 4, 5, 6.
158	Tube	Special	Material: Cast iron and/or steel formers (material at the discretion of the Company) Ideal for bending: Mild steel tubes (R= 42Kg/mm ² - L.E. 250 N/mm ²), stainless steel and similars Tube dimension: Radius and diameters upon request.

Former article

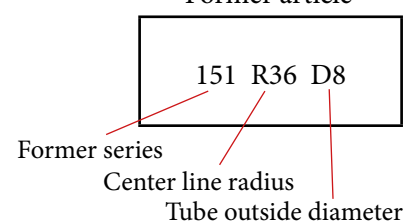

*Tools legend: Standard = Standard radius and diameter;
Semi-special = Standard radius and special diameter;
Special = Special radius and diameter.

Serie articolo	Sezione	Utensili*	Descrizione
151 153 153/1	Tubo (R36, R46, R56, R67, R82, R112)	Standard	Materiale: Matrici in ghisa Ideale per creare: Tubi in acciaio ferroso (R= 42Kg/mm ² - L.E. 250 N/mm ²), rame crudo e simili (con spessore inferiore a 3.6 mm) Dimensione tubi: Raggi e diametri disponibili standard. Spessori minimi: consultare tabelle 7, 8, 9.
151_E 153_E 153/1_E	Tubo (R90, R100, R130, R150)	Standard	Materiale: Matrici in ghisa Ideale per creare: Tubi in acciaio ferroso (R= 42Kg/mm ² - L.E. 250 N/mm ²), rame crudo e simili (con spessore inferiore a 3.6 mm) Dimensione tubi: Raggi e diametri disponibili standard. Spessori minimi: consultare tabelle 7, 8, 9.
151L 153L 153/1L	Tubo (R36, R46, R56, R67, R82, R112)	Standard	Materiale: Matrici serie leggera in ghisa Ideale per creare: Acciaio inox, materiali morbidi come alluminio (escluso rame); Applicazioni ornamentali (dove la presenza di segni sul tubo è ridotta al minimo) Applicazioni idrauliche (con spessore del profilo superiore a 3.6 mm e inferiore a 5 mm) Dimensione tubi: Raggi e diametri disponibili standard. Spessori minimi: consultare tabelle 7, 8, 9.
151L_E 153L_E 153/1L_E	Tubo (R90, R100, R130, R150)	Standard	Materiale: Matrici serie leggera in ghisa Ideale per creare: Acciaio inox, materiali morbidi come alluminio (escluso rame); Applicazioni ornamentali (dove la presenza di segni sul tubo è ridotta al minimo) Applicazioni idrauliche (con spessore del profilo superiore a 3.6 mm e inferiore a 5 mm) Dimensione tubi: Raggi e diametri disponibili standard. Spessori minimi: consultare tabelle 7, 8, 9.
190 193 193/1	Tubo	Standard	Materiale: Matrici in alluminio Ideale per creare: Tubi in acciaio ferroso (R= 42Kg/mm ² - L.E. 250 N/mm ²), acciaio inox, alluminio, rame crudo e simili (con spessore massimo 1.5 mm) Dimensione tubi: Raggi e diametri su richiesta. Spessori minimi: consultare tabelle 10, 11, 12.
156_E	Tubo (R90, R100, R130, R150)	Semispeciale	Materiale: Matrici in ghisa Ideale per creare: Tubi in acciaio ferroso (R= 42Kg/mm ² - L.E. 250 N/mm ²), rame crudo e simili (con spessore inferiore a 3.6 mm) Dimensione tubi: Raggi disponibili standard e diametri su richiesta.
156	Tubo (R36, R46, R56, R67, R82, R112)	Semi-speciale	Materiale: Matrici in ghisa Ideale per creare: Acciaio inox, materiali morbidi come alluminio (escluso rame); Applicazioni ornamentali (dove la presenza di segni sul tubo è ridotta al minimo) Applicazioni idrauliche (con spessore del profilo superiore a 3.6 mm e inferiore a 5 mm) Dimensione tubi: Raggi disponibili standard e diametri su richiesta.
156L	Tubo (R36, R46, R56, R67, R82, R112)	Semi-speciale	Materiale: Matrici serie leggera in ghisa Ideale per creare: Acciaio inox, materiali morbidi come alluminio (escluso rame); Applicazioni ornamentali (dove la presenza di segni sul tubo è ridotta al minimo) Applicazioni idrauliche (con spessore del profilo superiore a 3.6 mm e inferiore a 5 mm) Dimensione tubi: Raggi disponibili standard e diametri su richiesta.
156L_E	Tubo (R90, R100, R130, R150)	Semi-speciale	Materiale: Matrici serie leggera in ghisa Ideale per creare: Acciaio inox, materiali morbidi come alluminio (escluso rame); Applicazioni ornamentali (dove la presenza di segni sul tubo è ridotta al minimo) Applicazioni idrauliche (con spessore del profilo superiore a 3.6 mm e inferiore a 5 mm) Dimensione tubi: Raggi disponibili standard e diametri su richiesta.
197/1	Tubo	Semi-speciale	Materiale: Matrici in alluminio Ideale per creare: Tubi in acciaio ferroso (R= 42Kg/mm ² - L.E. 250 N/mm ²), acciaio inox, alluminio, rame crudo e simili (con spessore massimo 1.5 mm) Dimensione tubi: Raggi disponibili standard e diametri su richiesta. Spessori minimi: consultare tabelle 11, 12.

*Legenda Utensili: Standard = Raggio e diametro standard;
Semi-speciale = Raggio standard e diametro speciale;
Speciale = Raggio e diametro speciale.

Serie articolo	Sezione	Utensili*	Descrizione
151 153 153/1	Tube (R36, R46, R56, R67, R82, R112)	Standard	Material: Cast iron formers Ideal for bending: Mild steel tubes (R= 42Kg/mm ² - L.E. 250 N/mm ²), hard copper and similars (with wall thickness smaller than 3.6 mm - 0.15") Tube dimension: Standard radius and diameters available. For minimum wall thickness see tables 7, 8, 9.
151_E 153_E 153/1_E	Tube (R90, R100, R130, R150)	Standard	Material: Cast iron formers Ideal for bending: Mild steel tubes (R= 42Kg/mm ² - L.E. 250 N/mm ²), hard copper and similars (with wall thickness smaller than 3.6 mm - 0.15") Tube dimension: Standard radius and diameters available. For minimum wall thickness see tables 7, 8, 9.
151L 153L 153/1L	Tube (R36, R46, R56, R67, R82, R112)	Standard	Material: Cast iron light series formers Ideal for bending: Stainless steel, soft material such as aluminium (except copper); Ornamental applications (where marks and scratches need to be minimal); Hydraulic applications (with thicknesses higher than 3.6mm/0.15" and smaller than 5 mm/0.2"). Tube dimension: Standard radius and diameters available. For minimum wall thickness see tables 7, 8, 9.
151L_E 153L_E 153/1L_E	Tube (R90, R100, R130, R150)	Standard	Material: Cast iron light series formers Ideal for bending: Stainless steel, soft material such as aluminium (except copper); Ornamental applications (where marks and scratches need to be minimal); Hydraulic applications (with thicknesses higher than 3.6mm/0.15" and smaller than 5 mm/0.2"). Tube dimension: Standard radius and diameters available. For minimum wall thickness see tables 7, 8, 9.
190 193 193/1	Tube	Standard	Material: Aluminium formers Ideal for bending: Mild steel tubes (R= 42Kg/mm ² - L.E. 250 N/mm ²), hard copper and similars (with wall thickness smaller than 3.6 mm - 0.15") Tube dimension: Radius and diameters upon request. For minimum wall thickness see tables 10, 11, 12.
156_E	Tube (R90, R100, R130, R150)	Semispecial	Material: Cast iron formers Ideal for bending: Mild steel tubes (R= 42Kg/mm ² - L.E. 250 N/mm ²), hard copper and similars (with wall thickness smaller than 3.6 mm - 0.15") Tube dimension: Standard radius available, diameters upon request.
156	Tube (R36, R46, R56, R67, R82, R112)	Semi-special	Material: Cast iron formers Ideal for bending: Stainless steel, soft material such as aluminium (except copper); Ornamental applications (where marks and scratches need to be minimal); Hydraulic applications (with thicknesses higher than 3.6mm/0.15" and smaller than 5 mm/0.2"). Tube dimension: Standard radius available, diameters upon request.
156L	Tube (R36, R46, R56, R67, R82, R112)	Semi-special	Material: Cast iron formers light series Ideal for bending: Stainless steel, soft material such as aluminium (except copper); Ornamental applications (where marks and scratches need to be minimal); Hydraulic applications (with thicknesses higher than 3.6mm/0.15" and smaller than 5 mm/0.2"). Tube dimension: Standard radius available, diameters upon request.
156L_E	Tube (R90, R100, R130, R150)	Semi-special	Material: Cast iron formers light series Ideal for bending: Stainless steel, soft material such as aluminium (except copper); Ornamental applications (where marks and scratches need to be minimal); Hydraulic applications (with thicknesses higher than 3.6mm/0.15" and smaller than 5 mm/0.2"). Tube dimension: Standard radius available, diameters upon request.
197/1	Tube	Semi-special	Material: Aluminium formers Ideal for bending: Mild steel tubes (R= 42Kg/mm ² - L.E. 250 N/mm ²), hard copper and similars (with wall thickness smaller than 3.6 mm - 0.15") Tube dimension: Standard radius available, diameters upon request. For minimum wall thickness see tables 10, 11, 12.

*Tools legend: Standard = Standard radius and diameter;
Semi-special = Standard radius and special diameter;
Special = Special radius and diameter.



MB070, MD083, MN092, MB42

Serie articolo Article series	Sezione Section	Utensili* Tools*	Descrizione Description
198	Tubo - Tube	Speciale Special	<p>Materiale: Matrici in ghisa e/o acciaio (il materiale è a discrezione dell'Azienda Costruttrice) Material: Steel and/or cast iron formers (material at the discretion of the Company)</p> <p>Ideale per creare: Tubi in acciaio ferroso (R= 42Kg/mm² - L.E. 250 N/mm²), rame crudo e simili Ideal for bending: Mild steel tubes (R= 42Kg/mm² - L.E. 250 N/mm²), hard copper and similars</p> <p>Dimensione tubi: Raggi e diametri su richiesta. Spessori minimi: consultare tabella 10. Tube dimension: Radius and diameters upon request. For minimum wall thickness see the table 10.</p>
198L	Tubo - Tube	Speciale Special	<p>Materiale: Matrici in ghisa e/o acciaio (il materiale è a discrezione dell'Azienda Costruttrice) Material: Steel and/or cast iron formers (material at the discretion of the Company)</p> <p>Ideale per creare: Tubi in acciaio ferroso (R= 42Kg/mm² - L.E. 250 N/mm²), rame crudo e simili Ideal for bending: Mild steel tubes (R= 42Kg/mm² - L.E. 250 N/mm²), hard copper and similars</p> <p>Dimensione tubi: Raggi e diametri su richiesta. Spessori minimi: consultare tabella 13, 14, 15. Tube dimension: Radius and diameters upon request. For minimum wall thickness see the tables 13, 14, 15.</p>
199	Profilato Profile	Speciale Special	<p>Materiale: Matrici in ghisa e/o acciaio (il materiale è a discrezione dell'Azienda Costruttrice) Material: Steel and/or cast iron formers (material at the discretion of the Company)</p> <p>Ideale per creare: Tubi in acciaio ferroso (R= 42Kg/mm² - L.E. 250 N/mm²), rame crudo e simili Ideal for bending: Mild steel tubes (R= 42Kg/mm² - L.E. 250 N/mm²), hard copper and similars</p> <p>Dimensione tubi: Raggi e diametri su richiesta. Tube dimension: Radius and diameters upon request.</p>

MB070, MD083, MN092, MB42, MB42P

Serie articolo Article series	Sezione Section	Utensili* Tools*	Descrizione Description
190 193 193/1	Tubo - Tube	Standard	<p>Materiale: Matrici in alluminio Material: Aluminium formers</p> <p>Ideale per creare: Tubi in acciaio ferroso (R= 42Kg/mm² - L.E. 250 N/mm²), acciaio inox, alluminio, rame crudo e simili (con spessore massimo 1.5 mm) Ideal for bending: Mild steel tubes (R= 42Kg/mm² - L.E. 250 N/mm²), stainless steel, aluminium, hard copper and similars (with 1.5 mm maximum wall thickness)</p> <p>Dimensione tubi: Raggi e diametri su richiesta. Spessori minimi: consultare tabella 10, 11, 12. Tube dimension: Radius and diameters upon request. For minimum wall thickness see the table 10, 11, 12.</p>
197/1	Tubo - Tube	Semi-speciale Semi-special	<p>Materiale: Matrici in alluminio Material: Aluminium formers</p> <p>Ideale per creare: Tubi in acciaio ferroso (R= 42Kg/mm² - L.E. 250 N/mm²), acciaio inox, alluminio, rame crudo e simili (con spessore massimo 1.5 mm) Ideal for bending: Mild steel tubes (R= 42Kg/mm² - L.E. 250 N/mm²), stainless steel, aluminium, hard copper and similars (with 1.5 mm maximum wall thickness)</p> <p>Dimensione tubi: Raggi e diametri su richiesta. Spessori minimi: consultare tabella 11, 12. Tube dimension: Radius and diameters upon request. For minimum wall thickness see the table 11, 12.</p>



Matrice standard in ghisa
Standard cast iron former



Matrice serie leggera in ghisa
Cast iron light series former



Matrice standard in alluminio
Standard aluminium former



Matrice Dx e Sx con antigrinza
Former L/R with anti-grain

*Legenda Utensili: Standard = Raggio e diametro standard;
Semi-speciale = Raggio standard e diametro speciale;
Speciale = Raggio e diametro speciale.

*Tools legend: Standard = Standard radius and diameter;
Semi-special = Standard radius and special diameter;
Special = Special radius and diameter.

MATRICI STANDARD: CAPACITÀ MASSIMA DI CURVATURA - STANDARD FORMERS: MAXIMUM BENDING CAPACITY

Raggio max - Max radius (mm)	TB180	TB130	TB100	TB80	MG030	HB60	TB60	TB050	SB48
Max raggio curvabile con contromatrici Max bending radius with counterbending die	800	700	400	420	315	270	240	240	240
Max raggio curvabile con rullo Max bending radius with special roll	800	700	400	270	380	340	300	300	300

Per tubi FE e simili For mild steel tubes and similars	TB180	TB130	TB100	TB80	MG030	HB60	TB60	TB050	SB48
Max Ø curvabile in mm Max bending capacity in mm	150	127	100	76	76	60	60	60	48
Max Ø curvabile in pollici OD Max bending capacity in OD inches	6"	5"	4"	3"	3"	2"	2" 3/8	2" 3/8	1" 7/8
Max Ø curvabile in pollici Gas Max bending capacity in Gas inches	6"	4"	3" 1/2	2" 1/2	2" 1/2	2"	2"	2"	1" 1/2
Spessore max del tubo in mm per matrici standard in ghisa (Serie 151, 153E, 153/1) Max tube wall thickness in mm for standard cast iron formers (series 151, 153E, 153/1)	na	na	na	3,6	3,6	3,6	3,6	3,6	3,6

Per tubi Inox, rame e simili For stainless steel, hard copper and similars tubes	TB180	TB130	TB100	TB80	MG030	HB60	TB60	TB050	SB48
Max Ø curvabile in mm Max bending capacity in mm	141,3	114,3	100	76	76	60	60	60	48
Max Ø curvabile in pollici OD Max bending capacity in OD inches	5" 1/2	4" 1/2	4"	3"	3"	2"	2" 3/8	2" 3/8	1" 7/8
Max Ø curvabile in pollici Gas Max bending capacity in Gas inches	5"	4"	3" 1/2	2" 1/2	2" 1/2	2"	1" 1/2	1" 1/2	1" 1/2
Spessore max del tubo in mm per matrici standard in ghisa (Serie 151, 153E, 153/1) Max tube wall thickness in mm for standard cast iron formers (Series 151, 153E, 153/1)	na	na	na	3,2	3	3	3	3	3

In funzione del materiale da curvare, i raggi indicati garantiscono un'ottima qualità di curva. Per raggi inferiori, contattare l'azienda costruttrice.
Depending on tube characteristics, the indicated radius guarantee a high quality bend. For smaller radius, contact the manufacturer.

Per tubi da Ø 5 a Ø 55 mm e spessore maggiore di 3,6 mm e fino a 5 mm, usare matrici serie leggera "L".

Per tubi con spessore superiore a 4 mm si raccomanda l'utilizzo dei rulli Art. 050J/P050I oppure Art. RS0100P/RS0100A (anziché la contromatrice) e le matrici serie 157.

For tubes with Ø from 5 to 55 mm and wall thickness higher than 3.6 mm and up to 5 mm, use the "light alloy" series formers "L".

For tubes with thickness higher than 4 mm, use the rolls Art. 050J/P050I or Art. RS0100P/RS0100A instead of counterbending die and formers series 157.

Raggio max - Max radius (mm)	MB42	MD070	MD083	MN092
Max raggio curvabile con contromatrici Max bending radius with counterbending die	260	190	190	190
Max raggio curvabile con rullo Max bending radius with special roll	300	225	225	/

Per tubi FE e simili - For mild steel tubes and similars Per tubi Inox, rame e simili For stainless steel, hard copper and similars tubes	MB42	MD070	MD083	MN092
Max Ø curvabile in mm Max bending capacity in mm	42	35	35	28
Max Ø curvabile in pollici OD Max bending capacity in OD inches	1" 5/8	1" 3/8	1" 3/8	1" 1/8
Max Ø curvabile in pollici Gas Max bending capacity in Gas inches	1" 1/2	1"	1"	3/4"
Spessore max del tubo in mm per matrici standard in alluminio (Serie 190, 193, 193/1) Max tube wall thickness in mm for standard aluminium formers (Series 190, 193, 193/1)	1,5	1,5	1,5	1,5
Spessore max del tubo in mm per matrici standard in ghisa (Serie 151, 153E, 153/1) Max tube wall thickness in mm for standard cast iron formers (Series 151, 153E, 153/1)	3,5	3,5	3,5	3,5

In funzione del materiale da curvare, i raggi indicati garantiscono un'ottima qualità di curva. Per raggi inferiori, contattare l'azienda costruttrice.
Depending on tube characteristics, the indicated radius guarantee a high quality bend. For smaller radius, contact the manufacturer.

Per tubi da Ø 5 a Ø 55 mm e spessore maggiore di 3,6 mm e fino a 5 mm, usare matrici serie leggera "L".

Per tubi con spessore superiore a 4 mm si raccomanda l'utilizzo dei rulli Art. 050J/P050I oppure Art. RS0100P/RS0100A (anziché la contromatrice) e le matrici serie 157.

For tubes with Ø from 5 to 55 mm and wall thickness higher than 3.6 mm and up to 5 mm, use the "light alloy" series formers "L".

For tubes with thickness higher than 4 mm, use the rolls Art. 050J/P050I or Art. RS0100P/RS0100A instead of counterbending die and formers series 157.



MATICI STANDARD: CAPACITÀ MASSIMA DI CURVATURA - STANDARD FORMERS: MAXIMUM BENDING CAPACITY

Raggio max - Max radius (mm)	TB180	TB130	TB100	TB80	MG030	HB60	TB60	TB050	SB48
Max raggio curvabile con contromatrici Max bending radius with counterbending die	800	700	400	420	315	270	240	240	240
Max raggio curvabile con rullo Max bending radius with special roll	800	700	400	270	380	340	300	300	300

Per tubi FE e simili For mild steel tubes and similars	TB180	TB130	TB100	TB80	MG030	HB60	TB60	TB050	SB48
Max Ø curvabile in mm Max bending capacity in mm	150	127	100	76	76	60	60	60	48
Max Ø curvabile in pollici OD Max bending capacity in OD inches	6"	5"	4"	3"	3"	2"	2" 3/8	2" 3/8	1" 7/8
Max Ø curvabile in pollici Gas Max bending capacity in Gas inches	6"	4"	3" 1/2	2" 1/2	2" 1/2	2"	2"	2"	1" 1/2
Spessore max del tubo in mm per matrici standard in ghisa (Serie 151, 153E, 153/1) Max tube wall thickness in mm for standard cast iron formers (series 151, 153E, 153/1)	na	na	na	3,6	3,6	3,6	3,6	3,6	3,6

Per tubi Inox, rame e simili For stainless steel, hard copper and similars tubes	TB180	TB130	TB100	TB80	MG030	HB60	TB60	TB050	SB48
Max Ø curvabile in mm Max bending capacity in mm	141,3	114,3	100	76	76	60	60	60	48
Max Ø curvabile in pollici OD Max bending capacity in OD inches	5" 1/2	4" 1/2	4"	3"	3"	2"	2" 3/8	2" 3/8	1" 7/8
Max Ø curvabile in pollici Gas Max bending capacity in Gas inches	5"	4"	3" 1/2	2" 1/2	2" 1/2	2"	1" 1/2	1" 1/2	1" 1/2
Spessore max del tubo in mm per matrici standard in ghisa (Serie 151, 153E, 153/1) Max tube wall thickness in mm for standard cast iron formers (Series 151, 153E, 153/1)	na	na	na	3,2	3	3	3	3	3

In funzione del materiale da curvare, i raggi indicati garantiscono un'ottima qualità di curva. Per raggi inferiori, contattare l'azienda costruttrice.
Depending on tube characteristics, the indicated radius guarantee a high quality bend. For smaller radius, contact the manufacturer.

Per tubi da Ø 5 a Ø 55 mm e spessore maggiore di 3,6 mm e fino a 5 mm, usare matrici serie leggera "L".

Per tubi con spessore superiore a 4 mm si raccomanda l'utilizzo dei rulli Art. 050J/P050I oppure Art. RS0100P/RS0100A (anziché la contromatrice) e le matrici serie 157.

For tubes with Ø from 5 to 55 mm and wall thickness higher than 3.6 mm and up to 5 mm, use the "light alloy" series formers "L".

For tubes with thickness higher than 4 mm, use the rolls Art. 050J/P050I or Art. RS0100P/RS0100A instead of counterbending die and formers series 157.

Raggio max - Max radius (mm)	MB42	MD070	MD083	MN092
Max raggio curvabile con contromatrici Max bending radius with counterbending die	260	190	190	190
Max raggio curvabile con rullo Max bending radius with special roll	300	225	225	/

Per tubi FE e simili - For mild steel tubes and similars Per tubi Inox, rame e simili For stainless steel, hard copper and similars tubes	MB42	MD070	MD083	MN092
Max Ø curvabile in mm Max bending capacity in mm	42	35	35	28
Max Ø curvabile in pollici OD Max bending capacity in OD inches	1" 5/8	1" 3/8	1" 3/8	1" 1/8
Max Ø curvabile in pollici Gas Max bending capacity in Gas inches	1" 1/2	1"	1"	3/4"
Spessore max del tubo in mm per matrici standard in alluminio (Serie 190, 193, 193/1) Max tube wall thickness in mm for standard aluminium formers (Series 190, 193, 193/1)	1,5	1,5	1,5	1,5
Spessore max del tubo in mm per matrici standard in ghisa (Serie 151, 153E, 153/1) Max tube wall thickness in mm for standard cast iron formers (Series 151, 153E, 153/1)	3,5	3,5	3,5	3,5

In funzione del materiale da curvare, i raggi indicati garantiscono un'ottima qualità di curva. Per raggi inferiori, contattare l'azienda costruttrice.
Depending on tube characteristics, the indicated radius guarantee a high quality bend. For smaller radius, contact the manufacturer.

Per tubi da Ø 5 a Ø 55 mm e spessore maggiore di 3,6 mm e fino a 5 mm, usare matrici serie leggera "L".

Per tubi con spessore superiore a 4 mm si raccomanda l'utilizzo dei rulli Art. 050J/P050I oppure Art. RS0100P/RS0100A (anziché la contromatrice) e le matrici serie 157.

For tubes with Ø from 5 to 55 mm and wall thickness higher than 3.6 mm and up to 5 mm, use the "light alloy" series formers "L".

For tubes with thickness higher than 4 mm, use the rolls Art. 050J/P050I or Art. RS0100P/RS0100A instead of counterbending die and formers series 157.



MATRICI STANDARD PER TB180, TB130, TB100, TB80 (mm) STANDARD FORMERS FOR TB180, TB130, TB100, TB80 (mm)

Serie art. ABBD - Art. series ABBD			
Art.	Esagono - Hexagon (mm)	Raggio - Radius (mm)	Ø disponibile - Ø available (mm)
ABBD73R260	110	260	73
ABBD73R260H8	80	260	73
ABBD76,2R260	110	260	76,2
ABBD76,2R260H8	80	260	76,2
ABBD88,9R300	110	300	88,9
ABBD88,9R300H8	80	300	88,9
ABBD101,6R300	110	300	101,6
ABBD101,6R300H8	80	300	101,6
ABBD88,9R350	110	350	88,9
ABBD88,9R350H8	80	350	88,9
ABBD101R350	110	350	101
ABBD101R350H8	80	350	101
ABBD114,3R350	110	350	114,3
ABBD114,3R350H8	80	350	114,3

NOTA BENE:

Esagono 40 mm disponibile su tutte le macchine;

Esagono 50 mm disponibile solo sulle macchine TB130, TB100, TB80, MG030, TB60, TB050, TB050EDT, SB48;

Esagono 80 mm disponibile solo sulle macchine TB130, TB100, TB80;

Esagono 110 mm disponibile solo sulla macchina TB130.

NOTE:

Hexagon 40 mm mounths on all machines;

Hexagon 50 mm mounths only on TB130, TB100, TB80, MG030, TB60, TB050, TB050EDT, SB48 machines;

Hexagon 80 mm mounths only on TB130, TB100, TB80 machines;

Hexagon 110 mm mounths only on TB130 machine.

MATRICI STANDARD - STANDARD FORMERS (mm)

Serie art. 151 - Art. series 151			
Art.	Esagono - Hexagon (mm)	Raggio - Radius (mm)	Ø disponibile - Ø available (mm)
151R36D...	40	36	5, 6, 8, 10, 12, 13, 14, 15, 16, 18, 19
151R46D...	40	46	14, 15, 16, 18, 19, 20, 22
151R56D...	40	56	18, 19, 20, 22, 24, 25, 26, 28
151R67D...	40	67	18, 19, 20, 22, 24, 25, 26, 28, 30, 32
151R82D...	40	82	24, 25, 26, 28, 30, 32, 35
151R90D...	50	90	25, 26, 28, 30, 32, 35, 38, 40, 42
151R100D...	50	100	25, 26, 28, 30, 32, 35, 38, 40, 42, 45, 48
151R112D...	40	112	28, 30, 32, 35, 38, 40, 42
151R120D...	50	120	32, 35, 38, 40, 42, 45, 48, 50, 54, 55
151R130D...	50	130	32, 35, 38, 40, 42, 45, 48, 50, 54, 55, 60
151R150D...	50	150	32, 35, 38, 40, 42, 45, 48, 50, 54, 55, 60
151R170D...	50	170	38, 40, 42, 45, 48, 50, 54, 55, 60
151R190D...	50	190	38, 40, 42, 45, 48, 50, 54, 55, 60

Per la Serie Leggera, gli articoli indicati variano in: 151 R36D...L, 151 R46D...L, ecc.

For light series formers, below articles change as follows: 151LR36D..., 151LR46D..., etc.



MATRICI STANDARD - STANDARD FORMERS (Pollici OD - OD inches)

Serie art. 153 - Art. series 153

Art.	Esagono - Hexagon (mm)	Raggio - Radius (mm)	Ø disponibile - Ø available (Pollici OD - OD inches)
153R36D...	40	36	1/4", 3/8", 1/2", 5/8"
153R46D...	40	46	5/8", 3/4", 7/8"
153R56D...	40	56	3/4", 7/8", 1", 1" 1/8
153R67D...	40	67	3/4", 7/8", 1", 1" 1/8, 1" 1/4
153R82D...	40	82	1", 1" 1/8, 1" 1/4, 1" 3/8
153R90D...	50	90	1", 1" 1/8, 1" 1/4, 1" 3/8, 1" 1/2, 1" 5/8
153R100D...	50	100	1", 1" 1/8, 1" 1/4, 1" 3/8, 1" 1/2, 1" 5/8, 1" 3/4, 1" 7/8
153R112D...	40	112	1" 1/8, 1" 1/4, 1" 3/8, 1" 1/2, 1" 5/8
153R120D...	50	120	1" 1/4, 1" 3/8, 1" 1/2, 1" 5/8, 1" 3/4, 1" 7/8, 2"
153R130D...	50	130	1" 1/4, 1" 3/8, 1" 1/2, 1" 5/8, 1" 3/4, 1" 7/8, 2", 2" 1/8, 2" 1/4, 2" 3/8
153R150D...	50	150	1" 1/4, 1" 3/8, 1" 1/2, 1" 5/8, 1" 3/4, 1" 7/8, 2", 2" 1/8, 2" 1/4, 2" 3/8
153R170D...	50	170	1" 1/2, 1" 5/8, 1" 3/4, 1" 7/8, 2", 2" 1/8, 2" 1/4, 2" 3/8
153R190D...	50	190	1" 1/2, 1" 5/8, 1" 3/4, 1" 7/8, 2", 2" 1/8, 2" 1/4, 2" 3/8

Per la Serie Leggera, gli articoli indicati variano in: 153 R36D...L, 153 R46D...L, ecc.

For light series formers, below articles change as follows: 153LR36D..., 153LR46D..., etc.

MATRICI STANDARD - STANDARD FORMERS (Pollici Gas - Gas inches)

Serie art. 153/1 - Art. series 153/1

Art.	Esagono - Hexagon (mm)	Raggio - Radius (mm)	Ø disponibile - Ø available (Pollici Gas - Gas inches)
153/1R36D...	40	36	1/4", 3/8"
153/1R46D...	40	46	3/8", 1/2"
153/1R56D...	40	56	3/8", 1/2", 3/4"
153/1R67D...	40	67	1/2", 3/4", 1"
153/1R82D...	40	82	3/4", 1"
153/1R90D...	50	90	3/4", 1", 1" 1/4
153/1R100D...	50	100	3/4", 1", 1" 1/4, 1" 1/2
153/1R112D...	40	112	1", 1" 1/4
153/1R120D...	50	120	1", 1" 1/4, 1" 1/2, 2"
153/1R130D...	50	130	1" 1/4, 1" 1/2, 2"
153/1R150D...	50	150	1" 1/4, 1" 1/2, 2"
153/1R170D...	50	170	1" 1/4, 1" 1/2, 2"
153/1R190D...	50	190	1" 1/4, 1" 1/2, 2"

Per la Serie Leggera, gli articoli indicati variano in: 153/1 R36D...L, 153/1 R46D...L, ecc.

For light series formers, below articles change as follows: 153/1LR36D..., 153/1LR46D..., etc.

MATRICI STANDARD - STANDARD FORMERS (mm)

Serie art. 151_E - Art. series 151_E

Art.	Esagono - Hexagon (mm)	Raggio - Radius (mm)	Ø disponibile - Ø available (mm)
151R90E...	40	90	25, 26, 28, 30, 32, 35, 38, 40, 42
151R100E...	40	100	25, 26, 28, 30, 32, 35, 38, 40, 42
151R130E...	40	130	32, 35, 38, 40, 42
151R150E...	40	150	32, 35, 38, 40, 42

Per la Serie Leggera, gli articoli indicati variano in: 151 R90E...L, 151 R100E...L, ecc.

For light series formers, below articles change as follows: 151LR90E..., 151LR100E..., etc.

MATRICI STANDARD - STANDARD FORMERS (Pollici OD - OD inches)

Serie art. 153_E - Art. series 153_E

Art.	Esagono - Hexagon (mm)	Raggio - Radius (mm)	Ø disponibile - Ø available (Pollici OD - OD inches)
153R90E...	40	90	1", 1" 1/8, 1" 1/4, 1" 3/8, 1" 1/2, 1" 5/8
153R100E...	40	100	1", 1" 1/8, 1" 1/4, 1" 3/8, 1" 1/2, 1" 5/8
153R130E...	40	130	1" 1/4, 1" 3/8, 1" 1/2, 1" 5/8
153R150E...	40	150	1" 1/4, 1" 3/8, 1" 1/2, 1" 5/8

Per la Serie Leggera, gli articoli indicati variano in: 153 R90E...L, 153 R100E...L, ecc.

For light series formers, below articles change as follows: 153LR90E..., 153LR100E..., etc.

MATRICI STANDARD - STANDARD FORMERS (Pollici Gas - Gas inches)

Serie art. 153/1_E - Art. series 153/1_E

Art.	Esagono - Hexagon (mm)	Raggio - Radius (mm)	Ø disponibile - Ø available (Pollici Gas - Gas inches)
153/1R90E...	40	90	3/4", 1", 1" 1/4
153/1R100E...	40	100	3/4", 1", 1" 1/4, 1" 1/2
153/1R130E...	40	130	1" 1/4, 1" 1/2, 2"
153/1R150E...	40	150	1" 1/4, 1" 1/2, 2"

Per la Serie Leggera, gli articoli indicati variano in: 153/1 R90E...L, 153/1 R100E...L, ecc.

For light series formers, below articles change as follows: 153/1LR90E..., 153/1LR100E..., etc.

MATRICI SEMISPECIALI PER TUBI - SEMISPECIAL FORMERS FOR TUBES (mm)

Serie art. ABBD...R - Art. series ABBD...R

Art.	Esagono - Hexagon (mm)	Raggio - Radius (mm)	Ø* min (mm)	Ø* max (mm)
ABBD...R260(1)	40	36	50	71
ABBD...R260H8(1)	40	46	50	71
ABBD...R260(2)	40	56	72	80
ABBD...R260H8(2)	40	67	72	80
ABBD...R300(1)	40	82	50	84
ABBD...R300H8(1)	50	90	50	84
ABBD...R300(2)	50	100	85	114,3
ABBD...R300H8(2)	40	112	85	114,3
ABBD...R350(1)	50	120	50	85
ABBD...R350H8(1)	50	130	50	85
ABBD...R350(2)	50	150	86	127
ABBD...R350H8(2)	50	170	86	127

*Specificare Ø del tubo. Spessore minimo curvabile 1 mm.

*Specify tube Ø. Minimum wall thickness 1 mm.

NOTA BENE:

Esagono 40 mm disponibile su tutte le macchine;
Esagono 50 mm disponibile solo sulle macchine TB130, TB100, TB80, MG030, TB60, TB050, TB050EDT, SB48;
Esagono 80 mm disponibile solo sulle macchine TB130, TB100, TB80;
Esagono 110 mm disponibile solo sulla macchina TB130.

NOTE:

Hexagon 40 mm mounths on all machines;
Hexagon 50 mm mounths only on TB130, TB100, TB80, MG030, TB60, TB050, TB050EDT, SB48 machines;
Hexagon 80 mm mounths only on TB130, TB100, TB80 machines;
Hexagon 110 mm mounths only on TB130 machine.



MATRICI SEMI-SPECIALI PER TUBI - SEMI-SPECIAL FORMERS FOR TUBES

Serie art. 156 - Art. series 156

Art.	Esagono Hexagon (mm)	Raggio Radius (mm)	Ø min (mm)*	Ø max (mm)*	Ø min (Pollici OD - OD inches)*	Ø max (Pollici OD - OD inches)*	Ø min (Pollici Gas - Gas inches)*	Ø max (Pollici Gas - Gas inches)*
156R36	40	36	5	19	1/4"	5/8"	1/4"	3/8"
156R46	40	46	5	22	1/4"	7/8"	1/4"	1/2"
156R56	40	56	5	28	1/4"	1" 1/8	1/4"	3/4"
156R67	40	67	5	32	1/4"	1" 1/4	1/4"	1"
156R82	40	82	5	35	1/4"	1" 3/8	1/4"	1"
156R90	50	90	5	42	1/4"	1" 5/8	1/4"	1" 1/2
156R100	50	100	5	48	1/4"	1" 7/8	1/4"	2"
156R112	40	112	5	42	1/4"	1" 5/8	1/4"	1"
156R120	50	120	5	55	1/4"	2"	1/4"	2"
156R130	50	130	5	60	1/4"	2" 3/8	1/4"	2"
156R150	50	150	5	60	1/4"	2" 3/8	1/4"	2"
156R170	50	170	5	60	1/4"	2" 3/8	1/4"	2"
156R190	50	190	5	60	1/4"	2" 3/8	1/4"	2"

*Specificare Ø del tubo. Spessore minimo curvabile 1 mm.

*Specify tube Ø. Minimum wall thickness 1 mm.

Per la Serie Leggera, gli articoli indicati variano in: 156 R36...L, 156 R46...L, ecc.

For light series formers, below articles change as follows: 156LR36..., 156LR46..., etc.

Serie art. 156_E - Art. series 156_E

Art.	Esagono Hexagon (mm)	Raggio Radius (mm)	Ø min (mm)*	Ø max (mm)*	Ø min (Pollici OD - OD inches)*	Ø max (Pollici OD - OD inches)*	Ø min (Pollici Gas - Gas inches)*	Ø max (Pollici Gas - Gas inches)*
156R90E	40	90	5	42	1/4"	1" 5/8	1/4"	1" 1/2
156R100E	40	100	5	48	1/4"	1" 7/8	1/4"	2"
156R130E	40	130	5	60	1/4"	2" 3/8	1/4"	2"
156R150E	40	150	5	60	1/4"	2" 3/8	1/4"	2"

*Specificare Ø del tubo. Spessore minimo curvabile 1 mm.

*Specify tube Ø. Minimum wall thickness 1 mm.

Per la Serie Leggera, gli articoli indicati variano in: 156 R90...L, 156 R100...L, ecc.

For light series formers, below articles change as follows: 156LR90..., 156LR100..., etc.

MATRICI SPECIALI - SPECIAL FORMERS

Serie art. ABBD_R... - Art. series ABBD_R...

Art.	Esagono - Hexagon (mm)	Raggio - Radius (mm)*	Ø min (mm)**	Ø max (mm)**
ABBD...R...1A	110	110 - 162	48	63
ABBD...R...2A	110	163 - 199	48	63
ABBD...R...2B	110	163 - 199	64	102
ABBD...R...3A	110	200 - 252	48	63
ABBD...R...3B	110	200 - 252	64	102
ABBD...R...4A	110	253 - 262	48	63
ABBD...R...4B	110	253 - 262	64	102
ABBD...R...5A	110	263 - 280	48	63
ABBD...R...5B	110	263 - 280	64	102

La tabella prosegue alla pagina seguente.
The table continues on the next page.



MATRICI SPECIALI - SPECIAL FORMERS

Serie art. ABBD_R... - Art. series ABBD_R...				
Art.	Esagono - Hexagon (mm)	Raggio - Radius (mm)*	Ø min (mm)**	Ø max (mm)**
ABBD...R...6A	110	281 - 302	48	63
ABBD...R...6B	110	281 - 302	64	102
ABBD...R...7A	110	303 - 323	48	63
ABBD...R...7B	110	303 - 323	64	102
ABBD...R...7C	110	303 - 323	103	140
ABBD...R...8A	110	324 - 352	48	63
ABBD...R...8B	110	324 - 352	64	102
ABBD...R...8C	110	324 - 352	103	140
ABBD...R...9A	110	353 - 420	48	63
ABBD...R...9B	110	353 - 420	64	102
ABBD...R...9C	110	353 - 420	103	140
ABBD...R...10A	110	421 - 500	48	63
ABBD...R...10B	110	421 - 500	64	102
ABBD...R...10C	110	421 - 500	103	140
ABBD...R...11A	110	501 - 560	48	63
ABBD...R...11B	110	501 - 560	64	102
ABBD...R...11C	110	501 - 560	103	140
ABBD...R...12A	110	561 - 700	48	63
ABBD...R...12B	110	561 - 700	64	102
ABBD...R...12C	110	561 - 700	103	140
ABBD...R...H81A	80	100 - 162	48	63
ABBD...R...H82A	80	163 - 199	48	63
ABBD...R...H82B	80	163 - 199	64	102
ABBD...R...H83A	80	200 - 252	48	63
ABBD...R...H83B	80	200 - 252	64	102
ABBD...R...H84A	80	253 - 262	48	63
ABBD...R...H84B	80	253 - 262	64	102
ABBD...R...H85A	80	263 - 280	48	63
ABBD...R...H85B	80	263 - 280	64	102
ABBD...R...H86A	80	281 - 302	48	63
ABBD...R...H86B	80	281 - 302	64	102
ABBD...R...H87A	80	303 - 323	48	63
ABBD...R...H87B	80	303 - 323	64	102
ABBD...R...H87C	80	303 - 323	103	140
ABBD...R...H88A	80	324 - 352	48	63
ABBD...R...H88B	80	324 - 352	64	102
ABBD...R...H88C	80	324 - 352	103	140
ABBD...R...H89A	80	353 - 420	48	63
ABBD...R...H89B	80	353 - 420	64	102
ABBD...R...H89C	80	353 - 420	103	140

NOTA BENE:

Esagono 40 mm disponibile su tutte le macchine;
 Esagono 50 mm disponibile solo sulle macchine TB130, TB100, TB80, MG030, TB60, TB050, TB050EDT, SB48;
 Esagono 80 mm disponibile solo sulle macchine TB130, TB100, TB80;
 Esagono 110 mm disponibile solo sulla macchina TB130.

NOTE:

Hexagon 40 mm mounths on all machines;
 Hexagon 50 mm mounths only on TB130, TB100, TB80, MG030, TB60, TB050, TB050EDT, SB48 machines;
 Hexagon 80 mm mounths only on TB130, TB100, TB80 machines;
 Hexagon 110 mm mounths only on TB130 machine.



MATRICI SPECIALI DESTRA E SINISTRA - SPECIAL LEFT-RIGHT FORMERS

Serie art. DSMD_R... - Art. series DSMD_R...				
Art.	Esagono - Hexagon (mm)	Raggio - Radius (mm)*	Ø min (mm)**	Ø max (mm)**
DSMD...R...1A	110	100 - 162	10	63,5
DSMD...R...2A	110	163 - 195	10	63,5
DSMD...R...2B	110	163 - 195	64	102
DSMD...R...3A	110	196 - 259	10	63,5
DSMD...R...3B	110	196 - 259	64	102
DSMD...R...4A	110	260 - 299	10	63,5
DSMD...R...4B	110	260 - 299	64	102
DSMD...R...5A	110	300 - 349	10	63,5
DSMD...R...5B	110	300 - 349	64	102
DSMD...R...5C	110	300 - 349	103	140
DSMD...R...6A	110	350 - 420	10	63,5
DSMD...R...6B	110	350 - 420	64	102
DSMD...R...6C	110	350 - 420	103	140
DSMD...R...7A	110	421 - 500	10	63,5
DSMD...R...7B	110	421 - 500	64	102
DSMD...R...7C	110	421 - 500	103	140
DSMD...R...8A	110	501 - 560	10	63,5
DSMD...R...8B	110	501 - 560	64	102
DSMD...R...8C	110	501 - 560	103	140
DSMD...R...9A	110	561 - 700	10	63,5
DSMD...R...9B	110	561 - 700	64	102
DSMD...R...9C	110	561 - 700	103	140
DSMD...R...H81A	80	100 - 162	10	63,5
DSMD...R...H82A	80	163 - 195	10	63,5
DSMD...R...H82B	80	163 - 195	64	102
DSMD...R...H83A	80	196 - 259	10	63,5
DSMD...R...H83B	80	196 - 259	64	102
DSMD...R...H84A	80	260 - 299	10	63,5
DSMD...R...H84B	80	260 - 299	64	102
DSMD...R...H85A	80	300 - 349	10	63,5
DSMD...R...H85B	80	300 - 349	64	102
DSMD...R...H85C	80	300 - 349	103	140
DSMD...R...H86A	80	350 - 420	10	63,5
DSMD...R...H86B	80	350 - 420	64	102
DSMD...R...H86B	80	350 - 420	103	140
DSMD...R...H87A	80	421 - 500	10	63,5
DSMD...R...H87B	80	421 - 500	64	102
DSMD...R...H87C	80	421 - 500	103	140

NOTA BENE:

Esagono 40 mm disponibile su tutte le macchine;
 Esagono 50 mm disponibile solo sulle macchine TB130, TB100, TB80, MG030, TB60, TB050, TB050EDT, SB48;
 Esagono 80 mm disponibile solo sulle macchine TB130, TB100, TB80;
 Esagono 110 mm disponibile solo sulla macchina TB130.

NOTE:

Hexagon 40 mm mounths on all machines;
 Hexagon 50 mm mounths only on TB130, TB100, TB80, MG030, TB60, TB050, TB050EDT, SB48 machines;
 Hexagon 80 mm mounths only on TB130, TB100, TB80 machines;
 Hexagon 110 mm mounths only on TB130 machine.



MATRICI SPECIALI PER TUBI - SPECIAL FORMERS FOR TUBES

Serie art. 157 - Art. series 157

Art.	Esagono Hexagon (mm)	Raggio Radius (mm)	Ø min (mm)**	Ø max (mm)**	Ø min (Pollici OD - OD inches)**	Ø max (Pollici OD - OD inches)**	Ø min (Pollici Gas - Gas inches)**	Ø max (Pollici Gas - Gas inches)**
157A ¹	40	R10 - R35	5	15	1/4"	5/8"	1/4"	3/8"
157B	40	R36 - R56	5	20	1/4"	3/4"	1/4"	3/8"
157C	40, 50	R57 - R82	5	35	1/4"	1" 3/8	1/4"	3/4" - 1" ⁴
157D	40, 50	R83 - R90	5	42	1/4"	1" 5/8	1/4"	1" - 1" 1/4 ⁴
157E	40, 50	R91 - R104	5	48	1/4"	1" 7/8	1/4"	1" 1/4
157F	40, 50	R105 - R120	5	50	1/4"	2"	1/4"	1" 1/2
157G	40, 50	R121 - R130	5	60	1/4"	1" 5/8	1/4"	1" 1/2
157H	40, 50	R131 - R150	5	60	1/4"	1" 5/8	1/4"	2"
157I	50	R151 - R170	5	60	1/4"	1" 5/8	1/4"	2"
157L	50	R171 - R190	5	60	1/4"	1" 5/8	1/4"	2"
157M	50	R191 - R225	5	60	1/4"	1" 5/8	1/4"	2"
157N	50	R226 - R260	5	60	1/4"	1" 5/8	1/4"	2"
157O	50	R261 - R300	5	60	1/4"	1" 5/8	1/4"	2"
157P ²	50	R191 - R225	42	76	1" 5/8	3"	1" 1/4	2" 1/2
157Q ²	50	R226 - R260	42	76	1" 5/8	3"	1" 1/4	2" 1/2
157R ²	50	R261 - R300	42	76	1" 5/8	3"	1" 1/4	2" 1/2
157S1 ³	50	R301 - R350	5	76	1/4"	3"	1/4"	2" 1/2
157S2 ³	50	R351 - R400	5	76	1/4"	3"	1/4"	2" 1/2
157S3 ³	50	R401 - R450	5	76	1/4"	3"	1/4"	2" 1/2
157S4 ³	50	R451 - R500	5	76	1/4"	3"	1/4"	2" 1/2

Per la Serie Leggera, gli articoli indicati variano in: 157AL, 157BL, ecc.

For light series formers, below articles change as follows: 157LA, 157LB, etc.

*I raggi di curvatura, entro le misure minime e massime in tabella, possono essere richieste con incrementi al singolo mm (es. da R10 a R35 = R10, R11, R12, ecc.).

**Il diametro del tubo deve rientrare nelle misure presenti in tabella.

¹ Usare lo speciale albero portautensile (Art. 050C). Per il modello MB42 è necessario l'utilizzo dell'albero portautensile speciale (Art. 042C).

² Sono utilizzabili solo con le Megabender MG76 e MG030.

³ Sono utilizzabili solo con i modelli macchina prolungati, che consentono di effettuare raggi di curvatura fino a 500 mm.

⁴ Il diametro massimo è in funzione del raggio richiesto.

*The bending radius may be requested within overranges for each size in mm (ex. from R10 to R35 = R10, R11, R12, etc.).

**The tube diameter must be within the ranges indicated in the table.

¹ To be used with the special shaft (Art. 050C). For model MB42 a special tooling holding shaft (Art. 042C) is required.

² Formers may only be used with MG76 and MG030 Megabenders.

³ Formers may only be used with special extended machine models, which allow bending radius up to 500 mm.

⁴ The maximum diameter depends upon the radius requested.



MATRICI SPECIALI ACCIAIO PER RAGGIO EFFETTIVO - SPECIAL CALIBRATED RADIUS STEEL FORMERS

Serie art. 157RE - Art. series 157RE

Art.	Esagono Hexagon (mm)	Raggio Radius (mm)	Ø min (mm)**	Ø max (mm)**	Ø min (Pollici OD - OD inches)**	Ø max (Pollici OD - OD inches)**	Ø min (Pollici Gas - Gas inches)**	Ø max (Pollici Gas - Gas inches)**
157A ¹ RE	40	R10 - R35	5	15	1/4"	5/8"	1/4"	3/8"
157B RE	40	R36 - R56	5	20	1/4"	3/4"	1/4"	3/8"
157C RE	40, 50	R57 - R82	5	35	1/4"	1" 3/8	1/4"	3/4" - 1" ⁴
157D RE	40, 50	R83 - R90	5	42	1/4"	1" 5/8	1/4"	1" - 1" 1/4 ⁴
157E RE	40, 50	R91 - R104	5	48	1/4"	1" 7/8	1/4"	1" 1/4
157F RE	40, 50	R105 - R120	5	50	1/4"	2"	1/4"	1" 1/2
157G RE	40, 50	R121 - R130	5	60	1/4"	1" 5/8	1/4"	1" 1/2
157H RE	40, 50	R131 - R150	5	60	1/4"	1" 5/8	1/4"	2"
157I RE	50	R151 - R170	5	60	1/4"	1" 5/8	1/4"	2"
157L RE	50	R171 - R190	5	60	1/4"	1" 5/8	1/4"	2"
157M RE	50	R191 - R225	5	60	1/4"	1" 5/8	1/4"	2"
157N RE	50	R226 - R260	5	60	1/4"	1" 5/8	1/4"	2"
157O RE	50	R261 - R300	5	60	1/4"	1" 5/8	1/4"	2"
157P ² RE	50	R191 - R225	42	76	1" 5/8	3"	1" 1/4	2" 1/2
157Q ² RE	50	R226 - R260	42	76	1" 5/8	3"	1" 1/4	2" 1/2
157R ² RE	50	R261 - R300	42	76	1" 5/8	3"	1" 1/4	2" 1/2
157S1 ³ RE	50	R301 - R350	5	76	1/4"	3"	1/4"	2" 1/2
157S2 ³ RE	50	R351 - R400	5	76	1/4"	3"	1/4"	2" 1/2
157S3 ³ RE	50	R401 - R450	5	76	1/4"	3"	1/4"	2" 1/2
157S4 ³ RE	50	R451 - R500	5	76	1/4"	3"	1/4"	2" 1/2

*I raggi di curvatura, entro le misure minime e massime in tabella, possono essere richieste con incrementi al singolo mm (es. da R10 a R35 = R10, R11, R12, ecc.).

**Il diametro del tubo deve rientrare nelle misure presenti in tabella.

¹ Usare lo speciale albero portautensile (Art. 050C). Per il modello MB42 è necessario l'utilizzo dell'albero portautensile speciale (Art. 042C).

² Sono utilizzabili solo con le Megabender MG76 e MG030.

³ Sono utilizzabili solo con i modelli macchina prolungati, che consentono di effettuare raggi di curvatura fino a 500 mm.

⁴ Il diametro massimo è in funzione del raggio richiesto.

*The bending radius may be requested within overranges for each size in mm (ex. from R10 to R35 = R10, R11, R12, etc.).

**The tube diameter must be within the ranges indicated in the table.

¹ To be used with the special shaft (Art. 050C). For model MB42 a special tooling holding shaft (Art. 042C) is required.

² Formers may only be used with MG76 and MG030 Megabenders.

³ Formers may only be used with special extended machine models, which allow bending radius up to 500 mm.

⁴ The maximum diameter depends upon the radius requested.

MATRICI SPECIALI ACCIAIO RINFORZATE CEMENTATE (per spessori superiori a 4 mm)
SPECIAL REINFORCED FORMERS (for wall thicknesses > 4 mm)

Serie art. 160 - Art. series 160

Art.	Esagono Hexagon (mm)	Raggio Radius (mm)	Ø min (mm)**	Ø max (mm)**	Ø min (Pollici OD - OD inches)**	Ø max (Pollici OD - OD inches)**	Ø min (Pollici Gas - Gas inches)**	Ø max (Pollici Gas - Gas inches)**
160A ¹	40	R10 - R35	5	15	1/4"	5/8"	1/4"	3/8"
160B	40	R36 - R56	5	20	1/4"	3/4"	1/4"	3/8"
160C	40, 50	R57 - R82	5	35	1/4"	1" 3/8	1/4"	3/4" - 1" ⁴
160D	40, 50	R83 - R90	5	42	1/4"	1" 5/8	1/4"	1" - 1" 1/4 ⁴
160E	40, 50	R91 - R104	5	48	1/4"	1" 7/8	1/4"	1" 1/4
160F	40, 50	R105 - R120	5	50	1/4"	2"	1/4"	1" 1/2
160G	40, 50	R121 - R130	5	60	1/4"	1" 5/8	1/4"	1" 1/2
160H	40, 50	R131 - R150	5	60	1/4"	1" 5/8	1/4"	2"
160I	50	R151 - R170	5	60	1/4"	1" 5/8	1/4"	2"
160L	50	R171 - R190	5	60	1/4"	1" 5/8	1/4"	2"
160M	50	R191 - R225	5	60	1/4"	1" 5/8	1/4"	2"
160N	50	R226 - R260	5	60	1/4"	1" 5/8	1/4"	2"
160O	50	R261 - R300	5	60	1/4"	1" 5/8	1/4"	2"
160P ²	50	R191 - R225	42	76	1" 5/8	3"	1" 1/4	2" 1/2
160Q ²	50	R226 - R260	42	76	1" 5/8	3"	1" 1/4	2" 1/2
160R ²	50	R261 - R300	42	76	1" 5/8	3"	1" 1/4	2" 1/2
160S1 ³	50	R301 - R350	5	76	1/4"	3"	1/4"	2" 1/2
160S2 ³	50	R351 - R400	5	76	1/4"	3"	1/4"	2" 1/2
160S3 ³	50	R401 - R450	5	76	1/4"	3"	1/4"	2" 1/2
160S4 ³	50	R451 - R500	5	76	1/4"	3"	1/4"	2" 1/2

Per la Serie Leggera, gli articoli indicati variano in: 160AL, 160BL, ecc.

For light series formers, below articles change as follows: 160LA, 160LB, etc.

*I raggi di curvatura, entro le misure minime e massime in tabella, possono essere richieste con incrementi al singolo mm (es. da R10 a R35 = R10, R11, R12, ecc.).

**Il diametro del tubo deve rientrare nelle misure presenti in tabella.

¹ Usare lo speciale albero portautensile (Art. 050C). Per il modello MB42 è necessario l'utilizzo dell'albero portautensile speciale (Art. 042C).

² Sono utilizzabili solo con le Megabender MG76 e MG030.

³ Sono utilizzabili solo con i modelli macchina prolungati, che consentono di effettuare raggi di curvatura fino a 500 mm.

⁴ Il diametro massimo è in funzione del raggio richiesto.

*The bending radius may be requested within overranges for each size in mm (ex. from R10 to R35 = R10, R11, R12, etc.).

**The tube diameter must be within the ranges indicated in the table.

¹ To be used with the special shaft (Art. 050C). For model MB42 a special tooling holding shaft (Art. 042C) is required.

² Formers may only be used with MG76 and MG030 Megabenders.

³ Formers may only be used with special extended machine models, which allow bending radius up to 500 mm.

⁴ The maximum diameter depends upon the radius requested.



MATRICI SPECIALI PER PROFILATI - SPECIAL FORMERS FOR PROFILES

Serie art. 158 - Art. series 158		
Art.	Esagono - Hexagon (mm)	Raggio - Radius (mm)*
158/1 ¹	40	R10 - R35
158/2	40	R36 - R56
158/3	40, 50	R57 - R82
158/4	40, 50	R83 - R90
158/5	40, 50	R91 - R104
158/6	40, 50	R105 - R120
158/7	40, 50	R121 - R130
158/8	40, 50	R131 - R150
158/9	50	R151 - R170
158/10	50	R171 - R190
158/11	50	R191 - R225
158/12	50	R226 - R260
158/13 ²	50	R261 - R300
158/14 ³	50	R301 - R350
158/15 ³	50	R351 - R400
158/16 ³	50	R401 - R450
158/17 ³	50	R451 - R500

*I raggi di curvatura, entro le misure minime e massime in tabella, possono essere richieste con incrementi al singolo mm (es. da R10 a R35 = R10, R11, R12, ecc.).

**Il diametro del tubo deve rientrare nelle misure presenti in tabella.

¹ Usare lo speciale albero portautensile (Art. 050C). Per il modello MB42 è necessario l'utilizzo dell'albero portautensile speciale (Art. 042C).

² Sono utilizzabili solo con le Megabender MG76 e MG030.

³ Sono utilizzabili solo con i modelli macchina prolungati, che consentono di effettuare raggi di curvatura fino a 500 mm.

⁴ Il diametro massimo è in funzione del raggio richiesto.

*The bending radius may be requested within aboveranges for each size in mm (ex. from R10 to R35 = R10, R11, R12, etc.).

**The tube diameter must be within the ranges indicated in the table.

¹ To be used with the special shaft (Art. 050C). For model MB42 a special tooling holding shaft (Art. 042C) is required.





² Formers may only be used with MG76 and MG030 Megabenders.

³ Formers may only be used with special extended machine models, which allow bending radius up to 500 mm.

⁴ The maximum diameter depends upon the radius requested.

In fase d'ordine è necessario indicare il verso di curvatura del profilato (Rif. A, B, C, ecc.), consultando la seguente tabella:
TABELLA IDENTIFICATIVA DEL VERSO DI CURVATURA

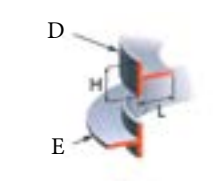
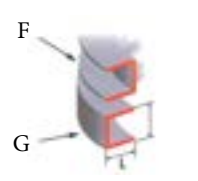
Upon ordering it is necessary to indicate the bending direction (Ref. A, B, C, etc.). Please refer to the following table:
PROFILE REFERENCE FOR BENDING DIRECTION

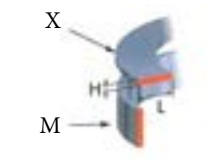
<p>Profilo quadro Square hollow profile</p> 	<p>Profilo rettangolare Rectangular hollow profile</p> 	<p>Profilo a T T-profile</p> 	<p>Profilo a U U-profile</p> 
<p>Tondo pieno Round bars</p> 	<p>Quadro Pieno Square bar</p> 	<p>Piatto pieno Flat bar</p> 	

Contattare l'Azienda Costruttrice per informazioni sui raggi di curvatura possibili.

Please contact the manufacturer for information on possible bending radius.

MATRICI SEMI-SPECIALI PER TUBI - SEMI-SPECIAL FORMERS FOR TUBES

Serie art. 197/1 - Art. series 197/1

Art.*	Esagono Hexagon (mm)	Raggio Radius (mm)	Ø min (mm)**	Ø max (mm)**	Ø min (Pollici OD - OD inches)**	Ø max (Pollici OD - OD inches)**	Ø min (Pollici Gas - Gas inches)**	Ø max (Pollici Gas - Gas inches)**
197/1R36	40	36	5	19	1/4"	1/2"	1/4"	1/4"
197/1R40	40	40	5	20	1/4"	3/4"	1/4"	3/8"
197/1R46	40	46	5	18	1/4"	5/8"	1/4"	3/8"
197/1R56	40	56	5	20	1/4"	7/8"	1/4"	1/2"
197/1R67	40	67	5	22	1/4"	7/8"	1/4"	1/2"
197/1R82	40	82	5	26	1/4"	1"	1/4"	3/4"
197/1R96	50	90	5	28	1/4"	1" 1/8	1/4"	3/4"
197/1R112	50	100	5	35	1/4"	1" 3/8	1/4"	1"
197/1R130	50	130	5	42	1/4"	1" 5/8	1/4"	1"
197/1R150	50	150	5	42	1/4"	1" 1/8	1/4"	3/4"
197/1R175	50	170	5	42	1/4"	1" 1/8	1/4"	1/2"
197/1R190	50	190	5	42	1/4"	1" 1/8	1/4"	1/2"
197/1R230 ¹	50	230	5	54	1/4"	2" 1/8	na	na
197/1R260 ¹	50	260	5	54	1/4"	2" 1/8	na	na

*Specificare diametro del tubo, attendendosi agli spessori minimi riportati nelle tabelle di capacità massima di curvatura. Spessore minimo curvabile 1 mm.

**Il diametro del tubo deve rientrare nelle misure presenti in tabella (da Ø 38 mm - 1" 1/2 a Ø 54 mm - 2" 1/8 solo per rame).

¹ Matrici utilizzabili solo con Medibender MB42 e MB42P.

*Specify tube diameter, abiding by the maximum wall thickness indicated in the maximum bending capacity tables. Minimum wall thickness 1 mm.

**Tube diameter must be in the above ranges (from Ø 38 mm - 1" 1/2 to Ø 54 mm - 2" 1/8 only for copper).

¹ Formers to be used only with Medibender MB42 and MB42P.

MATRICI SPECIALI PER TUBI - SPECIAL FORMERS FOR TUBES

Serie art. 198 - Art. series 198

Art.	Esagono Hexagon (mm)	Raggio Radius (mm)	Ø min (mm)**	Ø max (mm)**	Ø min (Pollici OD - OD inches)**	Ø max (Pollici OD - OD inches)**	Ø min (Pollici Gas - Gas inches)**	Ø max (Pollici Gas - Gas inches)**
198A ¹	40	R10 - R35	5	15	1/4"	5/8"	1/4"	1/4"
198B	40	R36 - R56	5	20	1/4"	3/4"	1/4"	3/8"
198C	40	R57 - R82	5	35	1/4"	1" 3/8	1/4"	1"
198D	40	R83 - R90	5	35	1/4"	1" 3/8	1/4"	1"
198E	40	R91 - R104	5	35	1/4"	1" 3/8	1/4"	1"
198F	40	R105 - R120	5	35	1/4"	1" 3/8	1/4"	1"
198G	40	R121 - R130	5	35	1/4"	1" 3/8	1/4"	1"
198H	40	R131 - R150	5	35	1/4"	1" 3/8	1/4"	1"
198I ²	40	R151 - R170	5	42	1/4"	1" 5/8	1/4"	1" 1/4
198K ²	40	R171 - R190	5	42	1/4"	1" 5/8	1/4"	1" 1/4
198L ²	40	R191 - R225	5	42	1/4"	1" 5/8	1/4"	1" 1/4
198M ²	40	R226 - R260	5	42	1/4"	1" 5/8	1/4"	1" 1/4

*I raggi di curvatura, entro le misure minime e massime in tabella, possono essere richieste con incrementi al singolo mm (es. da R10 a R35 = R10, R11, R12, ecc.).

**Il diametro del tubo deve rientrare nelle misure presenti in tabella.

¹ Può essere usato solo con mod. MD071 e MN092. Per il modello MB42 è necessario l'utilizzo della matrice Art. 157A con l'albero portautensile speciale (Art. 042C).

² Sono utilizzabili solo con i mod. MB42 e MB42P.

*The bending radius may be requested within overranges for each size in mm (ex. from R10 to R35 = R10, R11, R12, etc.).

**The tube diameter must be within the ranges indicated in the table.

¹ Formers may only be used with MD071 and MN092 models. For model MB42 a former Art. 157A with a special tooling holding shaft (Art. 042C) is required.

² Formers may only be used with MB42 and MB42P models.



MATRICI SPECIALI PER PROFILATI - SPECIAL FORMERS FOR PROFILES

Serie art. 199 - Art. series 199		
Art.	Esagono - Hexagon (mm)	Raggio - Radius (mm)*
199/1 ¹	40	R10 - R35
158/2	40	R36 - R56
158/3	40	R57 - R82
158/4	40	R83 - R90
158/5	40	R91 - R104
158/6	40	R105 - R120
158/7	40	R121 - R130
158/8	40	R131 - R150
158/9	40	R151 - R170
158/10	40	R171 - R190
158/11 ²	40	R191 - R225
158/12 ²	40	R226 - R260

*I raggi di curvatura, entro le misure minime e massime in tabella, possono essere richieste con incrementi al singolo mm (es. da R10 a R35 = R10, R11, R12, ecc.).

¹ La matrice può essere utilizzata solo con mod. MD071 e MN092. Per il modello MB42 è necessario l'utilizzo della matrice Art. 158/1 con l'albero portautensile speciale (Art. 042C). In alcuni casi è necessario, a discrezione dell'Azienda Costruttrice, l'utilizzo dell'albero integrale (Art. 042S).

² Le matrici sono utilizzabili solo con i mod. MB42 e MB42P.







*The bending radius may be requested within aboveranges for each size in mm (ex. from R10 to R35 = R10, R11, R12, etc.).

¹ Formers may only be used with MD071 and MN092 models. For model MB42 a former Art. 158/A with a special tooling holding shaft (Art. 042C) is required. In some cases it may be necessary, after the manufacturer evaluation, the use of a special former (Art. 042S).

² Formers may only be used with MB42 and MB42P models.

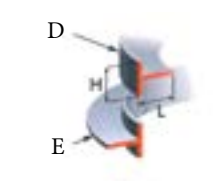
In fase d'ordine è necessario indicare il verso di curvatura del profilato (Rif. A, B, C, ecc.), consultando la seguente tabella:
TABELLA IDENTIFICATIVA DEL VERSO DI CURVATURA

Upon ordering it is necessary to indicate the bending direction (Ref. A, B, C, etc.). Please refer to the following table:
PROFILE REFERENCE FOR BENDING DIRECTION

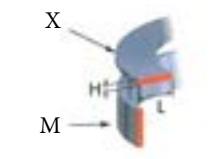
<p>Profilo quadro Square hollow profile</p> 	<p>Profilo rettangolare Rectangular hollow profile</p> 	<p>Profilo a T T-profile</p> 	<p>Profilo a U U-profile</p> 
<p>Tondo pieno Round bars</p> 	<p>Quadro Pieno Square bar</p> 	<p>Piatto pieno Flat bar</p> 	

Contattare l'Azienda Costruttrice per informazioni sui raggi di curvatura possibili.

Please contact the manufacturer for information on possible bending radius.

TABELLE MATRICI: SPESSORI MINIMI - FORMER TABLES: MINIMUM WALL THICKNESSES

Per una facile consultazione delle "Tabelle Matrici: Spessori Minimi" nelle pagine successive, tenere in considerazione quanto segue:

For an easier consultation of "Former Tables: Minimum wall Thicknesses" on the following pages, please see below:

Esagono	Raggio (R)	DIAMETRI (D)											SPESSORI MINIMI (in mm)
		5	6	8	10	12	13	14	15	16	18	19	
40	36	1	1	1	1	1	1	1.5	1.5	1.5			
		1	1	1	1	1	1	1.5	1.5	1.5	2	2.5	
40	46							1	1	1	2	2	
								1	1	1	1.5	2	
40	56										1	2	
											1	1.5	

DIAMETRO (D)

RAGGIO (R)

SPESSORE MINIMO

DIAMETRI MASSIMI

Diametro esterno del tubo

Raggio di curvatura (centro tubo)

Spessore minimo del tubo per il quale l'Azienda Costruttrice garantisce un ottimo risultato di curva

Capacità massima delle macchine indicate

Incrociando nella tabella i parametri Raggio (R) e Diametro (D) si incontrerà una casella in cui sono evidenziati gli spessori minimi per realizzare la curvatura:

- in **rosso**: spessore min. per tubi in acciaio ferroso (R = 42 Kg/mm² - L.E. 250 N/mm²) e simili;

- in **blu**: spessore min. per tubi in acciaio inox, rame crudo, alluminio e simili.

DIAMETER (D)

RADIUS (R)

MINIMUM WALL THICKNESS

MAXIMUM DIAMETERS

Tube outside diameter

Bending radius (center line)

Minimum tube wall thickness for which the manufacturer guarantees best bending results

Maximum capacities indicated for machines

By crossing the Diameter (D) and the Radius (R) parameters, the cross-over cell indicates the minimum wall thickness possible:

- in **red**: min. wall thickness for mild steel tubes (R = 42 Kg/mm² - L.E. 250 N/mm²) and similars;

- in **blue**: min. wall thickness for stainless steel, hard copper, aluminium tubes and similars.

TABELLA 1 - MATRICI STANDARD IN GHISA - Ø mm - Art. 151 R_D
 TABLE 1 - STANDARD CAST IRON FORMERS - Ø mm - Art. 151 R_D

Hexagon	Radius (R)	DIAMETERS (D) mm																												MAXIMUM DIAMETERS							
		5	6	8	10	12	13	14	15	16	18	19	20	22	24	25	26	28	30	32	35	38	40	42	45	48	50	54	55	60	73	76	SB48 - SB060	TB60 - TB050	MG76 - MG030		
40	36	1	1	1	1	1	1	1.5	1.5	1.5	2	2.5																									
40	46						1	1	1	1.5	2	2	2																								
40	56										1	1.5	1.5	1.5	2	2	2	2.5																			
40	67										1	1.5	1.5	1.5	2	2	2.5	2.5																			
40	82										1	1	1	1	1	2	2	2	3.5																		
50	90										1	1	1	1	2	2	2	3	2.5	3	3.2																
50	100										1	1	1	1	2	2	2.5	2.5	2	2	3	3	3	3	3												
40	112										1	1.2	1.2	2	2	2	2	2	2.5	2.5	2.5	2.5															
50	120																																				
50	130																																				
50	150																																				
50	170																																				
50	190																																				

MINIMUM WALL THICKNESS (mm)

TABELLA 2 - MATRICI STANDARD IN GHISA - Ø Pollici OD - Art. 153 R_D
 TABLE 2 - STANDARD CAST IRON FORMERS - Ø OD inches - Art. 153 R_D

Esagono	Raggio (R)	DIAMETRI (D)																	DIAMETRI MASSIMI																			
		1/4"	3/8"	1/2"	5/8"	3/4"	7/8"	1"	1 1/8"	1 1/4"	1 3/8"	1 1/2"	1 5/8"	1 3/4"	1 7/8"	2"	2 1/8"	2 1/4"	2 3/8"	3"	SB48 - SB060	TB60 - TB050	MG76 - MG030															
40	36	1	1	1	2																																	
40	46				1	2	2																															
40	56					1.5	1.5	2	2.5																													
40	67					1	1	1.5	2	2.5																												
40	82							1	1	2	2																											
50	90							1	1	2	2	3	3																									
50	100							1	1	2	2	2	2	3	3	3																						
40	112							1	1	1	2	2	2	2	2	3.2																						
50	120																																					
50	130																																					
50	150																																					
50	170																																					
50	190																																					

SPessori MINIMI (in mm)



TABELLA 3 - MATRICI STANDARD IN GHISA - Ø Pollici Gas - Art. 153/1 R_D_
TABLE 3 - STANDARD CAST IRON FORMERS - Ø Gas inches - Art. 153/1 R_D_

Esagono	Raggio (R)	DIAMETRI (D)									DIAMETRI MASSIMI			
		1/4"	3/8"	1/2"	3/4"	1"	1 1/4"	1 1/2"	2"	2 1/2"	SB48 - SB060	TB60 - TB050	MG76 - MG030	
40	36	1	1.5											
40	46	1	1.5											
40	56		1	2	2.5									
40	67			1	2	2.5								
40	82				1	2								
50	90				1.5	2	3,2							
50	100				1	2	3	3.5						
40	112				1	2,5	2,5							
50	120					1	2	3	3					
50	130						1.5	3	3					
50	150						1.2	2.5	2.5					
50	170						1.2	2	2.5					
50	190						1	1.5	2					

TABELLA 4 - MATRICI SPECIALI IN GHISA - Ø mm - Art. 157 R_D_
TABLE 4 - SPECIAL CAST IRON FORMERS - Ø mm - Art. 157 R_D_

Esagono	Raggio (R)	DIAMETRI (D)																												DIAMETRI MASSIMI				
		5	6	8	10	12	13	14	15	16	18	19	20	22	24	25	26	28	30	32	35	38	40	42	45	48	50	54	55	60	73	76		
50	225	1	1	1	1	1	1	1	1	1	1	1	1	1	1	1	1	1	1	1	1	1	1	1	1	1	1.2	1.5	1.5	1.5	2			
50	250	1	1	1	1	1	1	1	1	1	1	1	1	1	1	1	1	1	1	1	1	1	1	1	1	1	1.2	1.5	1.5	1.5	2	3	3.5	
50	260	1	1	1	1	1	1	1	1	1	1	1	1	1	1	1	1	1	1	1	1	1	1	1	1	1	1	1.2	1.5	1.5	1.5	2	na	na
50	300	1	1	1	1	1	1	1	1	1	1	1	1	1	1	1	1	1	1	1	1	1	1	1	1	1	1	1	1	1	1.2	2.5	2.5	

TABELLA 5 - MATRICI SPECIALI IN GHISA - Ø Pollici OD - Art. 157 R_D_
TABLE 5 - SPECIAL CAST IRON FORMERS - Ø OD inches - Art. 157 R_D_

Esagono	Raggio (R)	DIAMETRI (D)													DIAMETRI MASSIMI																					
		1/4"	3/8"	1/2"	5/8"	3/4"	7/8"	1"	1 1/8"	1 1/4"	1 3/8"	1 1/2"	1 5/8"	1 3/4"	1 7/8"	2"	2 1/8"	2 1/4"	2 3/8"	3"																
50	225	1	1	1	1	1	1	1	1	1	1	1	1	1	1.2	1.2	1.5	1.5	2	2.5	2.5	2.5														
50	250	1	1	1	1	1	1	1	1	1	1	1	1	1	1	1.2	1.2	1.5	1.5	2	2.5	2.5	2.5	3												
50	260	1	1	1	1	1	1	1	1	1	1	1	1	1	1	1	1.5	2	2	3	3	3	3	na												
50	300	1	1	1	1	1	1	1	1	1	1	1	1	1	1	1	1	1	1	1	1	1	1	1	1	1	1	1	1	1	1	1.2	2			

TABELLA 6 - MATRICI SPECIALI IN GHISA - Ø Pollici Gas - Art. 157 R_D_
TABLE 6 - SPECIAL CAST IRON FORMERS - Ø Gas inches - Art. 157 R_D_

Esagono	Raggio (R)	DIAMETRI (D)									DIAMETRI MASSIMI				
		1/4"	3/8"	1/2"	3/4"	1"	1 1/4"	1 1/2"	2"	2 1/2"	SB48 - SB060	TB60 - TB050	MG76 - MG030		
50	225	1	1	1	1	1	1	1	1	1	1.2	2			
50	250	1	1	1	1	1	1	1	1	1	1.2	2	3		
50	260	1	1	1	1	1	1	1	1	1	1	1.5	2.5		
50	300	1	1	1	1	1	1	1	1	1	1	1	1	2	



TABELLA 7 - MATRICI STANDARD IN GHISA - Ø mm - Art. 151 R_D_ / TABLE 7 - STANDARD CAST IRON FORMERS - Ø mm - Art. 151 R_D_

Esagono	Raggio (R)	DIAMETRI MASSIMI																							
		Diametri (D)												Diametri (D)											
		MD071						MN092			MD070 - MD083						MB42								
		5	6	8	10	12	13	14	15	16	18	19	20	22	24	25	26	28	30	32	35	38	40	42	
40	36	1	1	1	1	1	1	1.5	1.5	1.5	na	na													
		1	1	1	1	1	1	1.5	1.5	1.5	2	2.5													
40	46							1	1	1	2	2	2	3											
								1	1	1	1.5	2	2	2	2										
40	56									1	2	2	2.5	2.5	2.5	2.5	2.5								
										1	1.5	1.5	1.5	1.5	na	na	na	na							
40	67									1	1	1	1	2	2	2	2	2.5							
										1	1	1	1.2	2	2	na	na								
40	82													1	1	1	2	2.5	2.5	2.5					
														2	2	2	3	na	na	na					
40	90°														1	1	1	2	2	2	2.5	3	3,5		
															1.5	1.5	2.5	2.5	2.5	na	na	na	na		
40	100°														1	1	1	2	2	2	2	2	3		
															1	1	2	2	2	3	na	na	na		
40	112																1	1.2	1.2	1.2	2	2	2,5		
																	1.5	2	2	2.5	na	na	2.5		
40	130°																		1	1	1.5	1.5	2		
																			1	1	2	2	2		
40	150°																			1	1	1.2	1.2		
																				1	1	1.5	2		

SPessori Minimi (in mm)

TABELLA 8 - MATRICI STANDARD IN GHISA - Ø Pollici OD - Art. 153 R_D_ / TABLE 8 - STANDARD CAST IRON FORMERS - Ø OD inches - Art. 153 R_D_

Esagono	Raggio (R)	DIAMETRI MASSIMI													
		DIAMETRI (D)												DIAMETRI (D)	
		MD071						MN092			MD070 - MD083			MB42	
		1/4"	3/8"	1/2"	5/8"	3/4"	7/8"	1"	1 1/8"	1 1/4"	1 3/8"	1 1/2"	1 5/8"		
40	36	1	1	1	2	na									
		1	1	1	2	2.5									
40	46				1	2	3								
					1	2	2								
40	56					1.5	2.5	2.5	2.5						
						1.5	1.5	na	na						
40	67					1	1	2	2.5						
						1	1.2	na	na						
40	82							1	2	2	2.5				
								1.5	2.5	na	na				
40	90°							1	1	2	2	3	3		
								1.5	2.5	2.5	na	na	na		
40	100°							1	1	2	2	2	2		
								1	2	2	2	na	na		
40	112								1	1	1.5	2	3		
									1	1.5	2.5	2.5	3		
40	130°								1	1	1.5	1.5			
									1	1	2	2			
40	150°								1	1	1.2	1.2			
									1	1	1.5	2			

TABELLA 9 - MATRICI STANDARD IN GHISA Ø Pollici Gas - Art. 153/1 R_D_ / TABLE 9 - STANDARD CAST IRON FORMERS Ø Gas inches - Art. 153/1 R_D_

Esagono	Raggio (R)	DIAMETRI MASSIMI						
		DIAMETRI (D)					DIAMETRI (D)	
		MD071			MD070 - MD083		MB42	
		1/4"	3/8"	1/2"	3/4"	1"	1 1/4"	1 1/2"
40	36	1	2					
		1	1.5					
40	46		1.5	2.5				
			1	2.5				
40	56			1	2	2.5		
				1	2	na		
40	67				1	2	2.5	
					1	na	na	
40	82					1.5	2	
						2		
40	90°					1	2	
						1.5	na	
40	100°					1	2	2
						1.5	3	na
40	112						1	3.2
							2.5	na
40	130°							1.5
								2
40	150°							1.2
								2

SPessori Minimi (in mm)



MATRICI STANDARD - STANDARD FORMERS (mm)

Serie art. 190 - Art. series 190

Art.	Esagono - Hexagon (mm)	Raggio - Radius (mm)	Ø disponibile - Ø available (mm)
190R36D...	40	36	5, 6, 8, 10, 12, 13, 14, 15
190R40D...	40	40	13, 14, 15, 16, 18
190R46D...	40	46	15, 16, 18
190R56D...	40	56	15, 16, 18, 19, 20
190R67D...	40	67	19, 20, 22
190R82D...	40	82	24, 25, 26
190R96D...	40	96	28
190R112D...	40	112	28, 30, 32, 35
190R130D...	40	130	30, 32, 35, 38, 40, 42

MATRICI STANDARD - STANDARD FORMERS (Pollici OD - OD inches)

Serie art. 193 - Art. series 193

Art.	Esagono - Hexagon (mm)	Raggio - Radius (mm)	Ø disponibile - Ø available (Pollici OD - OD inches)
193R36D...	40	36	1/4", 3/8", 1/2"
193R40D...	40	40	1/2", 5/8"
193R46D...	40	46	5/8"
193R67D...	40	67	3/4", 7/8"
193R82D...	40	82	1"
193R96D...	40	96	1", 1" 1/8
193R112D...	40	112	1", 1" 1/8, 1" 1/4
193R130D...	40	130	1", 1" 1/8, 1" 1/4, 1" 1/2, 1" 5/8

MATRICI STANDARD - STANDARD FORMERS (Pollici Gas - Gas inches)

Serie art. 193/1 - Art. series 193/1

Art.	Esagono - Hexagon (mm)	Raggio - Radius (mm)	Ø disponibile - Ø available (Pollici Gas - Gas inches)
193/1R36D...	40	36	1/4"
193/1R40D...	40	40	1/4", 3/8"
193/1R67D...	40	67	1/2"
193/1R82D...	40	82	3/4"
193/1R112D...	40	112	1"

NOTA BENE:

Esagono 40 mm disponibile su tutte le macchine;
 Esagono 50 mm disponibile solo sulle macchine TB130, TB100, TB80, MG030, TB60, TB050, TB050EDT, SB48;
 Esagono 80 mm disponibile solo sulle macchine TB130, TB100, TB80;
 Esagono 110 mm disponibile solo sulla macchina TB130.

NOTE:

Hexagon 40 mm mounths on all machines;
 Hexagon 50 mm mounths only on TB130, TB100, TB80, MG030, TB60, TB050, TB050EDT, SB48 machines;
 Hexagon 80 mm mounths only on TB130, TB100, TB80 machines;
 Hexagon 110 mm mounths only on TB130 machine.



CONTROMATRICI STANDARD PER TUBI - STANDARD COUNTERBENDING DIES FOR TUBES

Serie articolo Article series	Macchine Machines	Descrizione Description
BPD_	TB100, TB130, TB80	Serie: Standard in ottone Series: Standard in brass Ideale per creare: Acciaio ferroso (R= 42 Kg/mm ² - L.E. 250 N/mm ²) e simili Ideal for bending: Mild steel tubes (R= 42 Kg/mm ² - L.E. 250 N/mm ²) and similars Dimensione tubi: Diametri disponibili standard. 88,9 - 101,60 - 114,3 mm. Tube dimension: Standard diameters available. 88,9 - 101,60 - 114,3 mm.
152 154 155	TB100, TB130, TB80, MG030, TB60, TB050, SB48, MB42, MB42P, MD070, MD083, MN092	Serie: Standard in ottone Series: Standard in brass Ideale per creare: Acciaio ferroso (R= 42 Kg/mm ² - L.E. 250 N/mm ²) e simili Ideal for bending: Mild steel tubes (R= 42 Kg/mm ² - L.E. 250 N/mm ²) and similars Dimensione tubi: Diametri disponibili standard. 88,9 - 101,60 - 114,3 mm. Tube dimension: Standard diameters available. 88,9 - 101,60 - 114,3 mm.
152L 154L 155L	TB100, TB130, TB80, MG030, TB60, TB050, SB48, MB42, MB42P, MD070, MD083, MN092	Serie: Standard in ottone Series: Standard in brass Ideale per creare: - Acciaio inox, materiali morbidi come alluminio (escluso rame) - Applicazioni ornamentali (dove la presenza di segni sul tubo è ridotta al minimo) Ideal for bending: - Stainless steel, soft material such as aluminium (except copper) - Ornamental applications (where marks and scratches need to be minimal) Dimensione tubi: Diametri disponibili standard. Tube dimension: Standard diameters available.
152R 154R	TB100, TB130, TB80, MG030, TB60, TB050, SB48, MB42, MB42P, MD070, MD083, MN092	Serie: Standard in ottone Series: Standard in brass Ideale per creare: Rame crudo Ideal for bending: Hard copper Dimensione tubi: Diametri disponibili standard. Tube dimension: Standard diameters available.
152A 154A 155A	TB100, TB130, TB80, MG030, TB60, TB050, SB48, MB42, MB42P, MD070, MD083, MN092	Serie: Standard in ghisa Series: Standard in cast iron Ideale per creare: Acciaio ferroso (R= 42 Kg/mm ² - L.E. 250 N/mm ²) e simili (carpenteria pesante) Ideal for bending: Mild steel tubes (R= 42 Kg/mm ² - L.E. 250 N/mm ²) and similars (heavy duty metalworking) Dimensione tubi: Diametri disponibili standard. Tube dimension: Standard diameters available.
152P 154P 155P	TB100, TB130, TB80, MG030, TB60, TB050, SB48, MB42, MB42P, MD070, MD083, MN092	Serie: Standard in polimero Series: Standard in nylon Ideale per creare: - Acciaio inox, materiali morbidi come alluminio (escluso rame) - Applicazioni ornamentali (dove la presenza di segni sul tubo è ridotta al minimo) Ideal for bending: - Stainless steel, soft material such as aluminium (except copper) - Ornamental applications (where marks and scratches need to be minimal) Dimensione tubi: Diametri disponibili standard. Tube dimension: Standard diameters available.



Contromatrice in ottone
Counterbending die in brass



Contromatrice in ottone (per rame)
Counterbending die in brass
(for copper)



Contromatrice in ghisa
Counterbending die in cast iron



Contromatrice in polimero
Counterbending die in nylon

Serie contromatrice
Counterbending die series

152 D28

Diametro esterno tubo
Tube outside diameter



CONTROMATRICI SPECIALI PER TUBI - SPECIAL COUNTERBENDING DIES FOR TUBES

Serie articolo Article series	Macchine Machines	Descrizione Description
BPD_	TB100, TB130, TB80, MG030, TB60, TB050, SB48, MB42, MB42P, MD070, MD083, MN092	Serie: Speciale in ottone Series: Special in brass Ideale per creare: Acciaio ferroso (R= 42 Kg/mm ² - L.E. 250 N/mm ²) e simili Ideal for bending: Mild steel tubes (R= 42 Kg/mm ² - L.E. 250 N/mm ²) and similars Dimensione tubi: Diametri disponibili su richiesta. Tube dimension: Diameters available upon request.
152O	TB100, TB130, TB80, MG030, TB60, TB050, SB48, MB42, MB42P, MD070, MD083, MN092	Serie: Speciale in ottone Series: Special in brass Ideale per creare: Acciaio ferroso (R= 42 Kg/mm ² - L.E. 250 N/mm ²) e simili Ideal for bending: Mild steel tubes (R= 42 Kg/mm ² - L.E. 250 N/mm ²) and similars Dimensione tubi: Diametri disponibili su richiesta. Tube dimension: Diameters available upon request.
152OL	TB100, TB130, TB80, MG030, TB60, TB050, SB48, MB42, MB42P, MD070, MD083, MN092	Serie: Speciale in ottone Series: Special in brass Ideale per creare: - Acciaio inox, materiali morbidi come alluminio (escluso rame) - Applicazioni ornamentali (dove la presenza di segni sul tubo è ridotta al minimo) Ideal for bending: - Stainless steel, soft material such as aluminium (except copper) - Ornamental applications (where marks and scratches need to be minimal) Dimensione tubi: Diametri disponibili su richiesta. Tube dimension: Diameters available upon request.
152/1	TB100, TB130, TB80, MG030, TB60, TB050, SB48, MB42, MB42P, MD070, MD083, MN092	Serie: Speciale in ottone Series: Special in brass Ideale per creare: Rame crudo Ideal for bending: Hard copper Dimensione tubi: Diametri disponibili su richiesta. Tube dimension: Diameters available upon request.
152A/	TB100, TB130, TB80, MG030, TB60, TB050, SB48, MB42, MB42P, MD070, MD083, MN092	Serie: Speciale in ghisa o acciaio Series: Special in cast iron or steel Ideale per creare: Acciaio ferroso (R= 42 Kg/mm ² - L.E. 250 N/mm ²) e simili (carpenteria pesante) Ideal for bending: Mild steel tubes (R= 42 Kg/mm ² - L.E. 250 N/mm ²) and similars (heavy duty metalworking) Dimensione tubi: Diametri disponibili su richiesta. Tube dimension: Diameters available upon request.
152N/	TB100, TB130, TB80, MG030, TB60, TB050, SB48, MB42, MB42P, MD070, MD083, MN092	Serie: Speciale in polimero e nylon Series: Special in nylon and polymer Ideale per creare: - Acciaio inox, materiali morbidi come alluminio (escluso rame) - Applicazioni ornamentali (dove la presenza di segni sul tubo è ridotta al minimo) Ideal for bending: - Stainless steel, soft material such as aluminium (except copper) - Ornamental applications (where marks and scratches need to be minimal) Dimensione tubi: Diametri disponibili su richiesta (con Ø max 40 mm). Tube dimension: Diameters available upon request (maximum Ø 40 mm).
152U	TB100, TB130, TB80, MG030, TB60, TB050, SB48, MB42, MB42P, MD070, MD083, MN092	Serie: Speciale in nylon, rinforzate con acciaio Series: Special in nylon, reinforced with steel Ideale per creare: - Acciaio inox, materiali morbidi come alluminio (escluso rame) - Applicazioni ornamentali (dove la presenza di segni sul tubo è ridotta al minimo) Ideal for bending: - Stainless steel, soft material such as aluminium (except copper) - Ornamental applications (where marks and scratches need to be minimal) Dimensione tubi: Diametri disponibili su richiesta (con Ø maggiore di 40 mm). Tube dimension: Diameters available upon request (with Ø larger than 40 mm).



Contromatrice in ottone
Counterbending die in brass



Contromatrice in ottone (per rame)
Counterbending die in brass (for copper)



Contromatrice in ghisa
Counterbending die in cast iron



Contromatrice in polimero
Counterbending die in nylon



Contromatrice in nylon/acciaio
Counterbending die in nylon/steel

CONTROMATRICI SPECIALI PER PROFILATI - SPECIAL COUNTERBENDING DIES FOR PROFILES

Serie articolo Article series	Macchine Machines	Descrizione Description
159	TB100, TB130, TB80, MG030, TB60, TB050, SB48, MB42, MB42P, MD070, MD083, MN092	<p>Serie: Speciale in acciaio Series: Special in steel</p> <p>Ideale per creare: Profilati in acciaio ferroso (R= 42 Kg/mm² - L.E. 250 N/mm²) e simili Ideal for bending: Mild steel profiles (R= 42 Kg/mm² - L.E. 250 N/mm²) and similars</p> <p>Dimensione tubi: Diametri disponibili su richiesta. Tube dimension: Diameters available upon request.</p>
159/O	TB100, TB130, TB80, MG030, TB60, TB050, SB48, MB42, MB42P, MD070, MD083, MN092	<p>Serie: Speciale in ottone Series: Special in brass</p> <p>Ideale per creare: Profilati in acciaio ferroso (R= 42 Kg/mm² - L.E. 250 N/mm²) e simili Ideal for bending: Mild steel profiles (R= 42 Kg/mm² - L.E. 250 N/mm²) and similars</p> <p>Dimensione tubi: Diametri disponibili su richiesta. Tube dimension: Diameters available upon request.</p>
159/P	TB100, TB130, TB80, MG030, TB60, TB050, SB48, MB42, MB42P, MD070, MD083, MN092	<p>Serie: Speciale in nylon Series: Special in nylon</p> <p>Ideale per creare: - Acciaio inox, materiali morbidi come alluminio (escluso rame) - Applicazioni ornamentali (dove la presenza di segni sul tubo è ridotta al minimo) Ideal for bending: - Stainless steel, soft material such as aluminium (except copper) - Ornamental applications (where marks and scratches need to be minimal)</p> <p>Dimensione tubi: Diametri disponibili su richiesta. Tube dimension: Diameters available upon request.</p>



Contromatrice in acciaio
Counterbending die in steel



Contromatrice in ottone
Counterbending die in brass



Contromatrice in polimero
Counterbending die in nylon

**CONTROMATRICI STANDARD PER TUBI
STANDARD COUNTERBENDING DIES FOR TUBES**
Art. 152, 154, 155

Art.	Ø (mm)	Art.	Ø (mm)	Art.	Ø (Pollici OD - OD inches)	Art.	Ø (Pollici Gas - Gas inches)
152-	5	152-	30	154-	1/4"	155-	1/4"
	6		32		3/8"		3/8"
	8		35		1/2"		1/2"
	10		38		5/8"		3/4"
	12		40		3/4"		1"
	13		42		7/8"		1"1/4
	14		45		1"		1"1/2
	15		48		1"1/8		2"
	16		50		1"1/4		2"1/2
	18		54		1"3/8		
	19		55		1"1/2		
	20		60		1"5/8		
	22		63		1"3/4		
	24		70		1"7/8		
25	73	2"					
26	76	2"1/8					
		2"1/4					
		2"3/8					
		3"					

Per la Serie Leggera, gli articoli indicati variano in: 152L..., 154L..., 155L...

For light series formers, below articles change as follows: 152L..., 154L..., 155L...

Art. 152R, 154R

Art.	Ø (mm)	Art.	Ø (Pollici OD - OD inches)
152R-	28	154R-	1"1/8
	35		1"3/8
	42		1"5/8
	45		1"3/4
	54		2"1/8

Art. 152A, 154A, 155A

Art.	Ø (mm)	Art.	Ø (Pollici OD - OD inches)	Art.	Ø (Pollici Gas - Gas inches)
152A-	35	154A-	1"5/8	155A-	1"
	42		1"7/8		1"1/4
	48		2"3/8		1"1/2
	60		2"		

Art. 152P, 154P, 155P

Art.	Ø (mm)	Art.	Ø (Pollici OD - OD inches)	Art.	Ø (Pollici Gas - Gas inches)
152P-	12	154P-	1/2"	155P-	1/2"
	13		5/8"		3/8"
	14		3/4"		
	15		7/8"		
	16				
	18				
	19				
	20				
22					

**CONTROMATRICI SPECIALI PER TUBI
SPECIAL COUNTERBENDING DIES FOR TUBES**

Art. 152O		
Art.	Min - max 0 (mm)*	Materiale - Material
152O/1...	12 - 17	ottone - brass
152O/2...	18 - 25	ottone - brass
152O/3...	26 - 31	ottone - brass
152O/4...	32 - 39	ottone - brass
152O/5...	40 - 53	ottone - brass
152O/6...	54 - 66	ottone - brass
152O/7...	67 - 76	ottone - brass

Per la Serie Leggera, gli articoli indicati variano in: 152OL/1... , 15OL/2... , ecc.

For light series formers, below articles change as follows: 152OL/1... , 15OL/2... , ecc.

Art. 152/1		
Art.	Min - max 0 (mm)*	Materiale - Material
152/1A...	12 - 17	ottone - brass
152/1B...	18 - 25	ottone - brass
152/1C...	26 - 31	ottone - brass
152/1D...	32 - 39	ottone - brass
152/1E...	40 - 53	ottone - brass
152/1F...	54 - 66	ottone - brass
152/1G...	67 - 76	ottone - brass

Art. 152A/		
Art.	Min - max 0 (mm)*	Materiale - Material
152A/1...	5 - 33	ghisa - cast iron
152A/2...	34 - 42	ghisa - cast iron
152A/3...	43 - 48	ghisa - cast iron
152A/4...	49 - 60	ghisa - cast iron
152A/5...	61 - 69	acciaio - steel
152A/6...	70 - 76	acciaio - steel

Art. 152N/		
Art.	Min - max 0 (mm)*	Materiale - Material
152N/1...	5 - 10	polimero - polymer
152N/2...	23 - 30	nylon
152N/3...	31 - 40	nylon

Art. 152U		
Art.	Min - max 0 (mm)*	Materiale - Material
152U1...	35 - 50	acciaio/nylon - steel/nylon
152U2...	51 - 60	acciaio/nylon - steel/nylon
152U3...	61 - 76	acciaio/nylon - steel/nylon

*Per tubi in pollici, verificare misure corrispondenti in mm.

*For tubes in inches, refer to the equivalent sizes in mm.



CONTROMATRICI SPECIALI PER PROFILATI - SPECIAL COUNTERBENDING DIES FOR PROFILES

Art. 159			
Art. (acciaio - steel)	Art. (ottone - brass)	Art. (nylon)	Rif. profilato - Rif. profile
159/1	159O/1	159/P1	A
159/2	159O/2	159/P2	B
159/3	159O/3	159/P3	C
159/4	159O/4	159/P4	D
159/5	159O/5	159/P5	E
159/6	159O/6	159/P6	F
159/7	159O/7	159/P7	G
159/8	159O/8	159/P8	X
159/9	159O/9	159/P9	M

RULLI SPECIALI PER PROFILATI PIENI - SPECIAL ROLLS FOR SOLID BARS

Art. rullo - Roll art.	Macchina - machine	Rif. profilato - Rif. profile
050J	MG76, MG030	Z e tubi con alti spessori I e tubi con alti spessori
P050I	TB60, TB050, SB48	Z e tubi con alti spessori I e tubi con alti spessori
084M	MB42, MB42P	Z e tubi con alti spessori I e tubi con alti spessori
P084B	MD070, MD083	Z e tubi con alti spessori I e tubi con alti spessori
092C	MN092	Z e tubi con alti spessori I e tubi con alti spessori
RS0100P	TB130, TB100	Z e tubi con alti spessori I e tubi con alti spessori
RS0100A	TB130, TB100	Z e tubi con alti spessori I e tubi con alti spessori



Art. 050J



Art. P050I



Art. 084M



Art. P084B

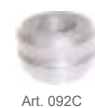





Art. 092C

In fase d'ordine è necessario indicare il verso di curvatura del profilato (Rif. A, B, C, ecc.), consultando la seguente tabella:

TABELLA IDENTIFICATIVA DEL VERSO DI CURVATURA

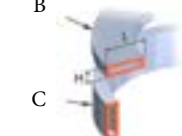
Upon ordering it is necessary to indicate the bending direction (Ref. A, B, C, etc.). Please refer to the following table:

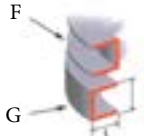
PROFILE REFERENCE FOR BENDING DIRECTION

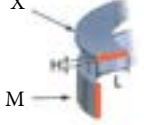
Profilo quadro Square hollow profile 	Profilo rettangolare Rectangular hollow profile 	Profilo a T T-profile 	Profilo a U U-profile 
Tondo pieno Round bars 	Quadro Pieno Square bar 	Piatto pieno Flat bar 	

Contattare l'Azienda Costruttrice per informazioni sui raggi di curvatura possibili.

Please contact the manufacturer for information on possible bending radius.

UTENSILI PER MORSA - TOOLING FOR VICE - MEDIBENDER MD070, MD083 - Art. 087



Art. 087 - Morsa su Medibender MD070 e MD083 per imbutire, flangiare, calibrare tubi.
 Art. 087 - Vice accessory on Medibender MD070 e MD083 for chamfering, flanging, calibrating tubes.

Ganasce, in mm ed in pollici, per il serraggio del tubo.
 Jaws, in mm and inches, to grip the tube.

GANASCE - JAWS

in mm		in Pollici OD - in OD inches	
Art.	Ø tubo - Ø tube	Art.	Ø tubo - Ø tube
300	12 - 14 - 18 - 28	400	3/8" - 1/2" - 5/8" - 3/4"
301	10 - 16 - 22 - 35	401	1" 1/8 - 7/8"
302	25 - 32	402	1" 1/4 - 1"
303	20 - 30	403	1" 3/8
304	36	404	1" 1/2
305	38	405	1" 5/8
306	40	406	Ø su richiesta - Ø upon request
307	15 - 42		
308	Ø su richiesta - Ø upon request		

PUNZONI PER IMBUTITURA - PUNCHES FOR EXPANDING

in mm			in Pollici OD - in OD inches		
Materiale: rame, ottone, alluminio crudo, acciaio ricotto Material: copper, brass, hard aluminium, stainless steel			Materiale: rame, ottone, alluminio, acciaio ricotto Material: copper, brass, aluminium, stainless steel		
Art.	Ø tubo - Ø tube	Spessore max - Max thickness	Art.	Ø tubo - Ø tube	Spessore max - Max thickness
310	10	1.5	410	3/8"	1.5
311	12	1.5	411	1/2"	1.5
312	14	1.5	412	5/8"	1.5
313	15	1.5	413	3/4"	1.5
314	16	1.5	414	7/8"	1.5
315	18	1.5	415	1"	1.5
316	20	1.5	416	1" 1/8	1.5
317	22	1.5	417	1" 1/4	1.5
318	25	1.5	418	1" 3/8	1.5
319	28	1.5	419	1" 1/2	1.5
320	30	1.5	420	1" 5/8	1.5
321	32	1.5	421	Ø su richiesta Ø upon request	1.5
322	35	1.5			
323	36	1.5			
324	38	1.5			
325	40	1.5			
326	42	1.5			
327	Ø su richiesta - Ø upon request				



PUNZONI PER RIDUZIONI - PUNCHES FOR REDUCING



in mm		
Materiale: rame, ottone, alluminio crudo, acciaio ricotto Material: copper, brass, hard aluminium, stainless steel		
Art.	Ø tubo - Ø tube	Spessore max - Max thickness
330	42 - 35	1
331	42 - 35	1.5
332	40 - 36	1
333	40 - 36	1.5
334	36 - 28	1
335	36 - 28	1.5
336	35 - 28	1
337	35 - 28	1.5
338	28 - 22	1
339	28 - 22	1.5
339/1	22 - 18	1
339/2	22 - 18	1.5
340	22 - 16	1
341	22 - 16	1.5
342	22 - 15	1
343	22 - 15	1.5
344	Ø su richiesta - Ø upon request	

Esempio: punzone per Ø 42 - 35 mm e sp. 1 mm, riduce un tubo da Ø 42 mm e sp. 1 mm in modo da potervi inserire un tubo Ø 35.

in Pollici OD - in OD inches		
Materiale: rame, ottone, alluminio, acciaio ricotto Material: copper, brass, aluminium, stainless steel		
Art.	Ø tubo - Ø tube	Spessore max - Max thickness
430	1" 5/8 - 1" 3/8	1
431	1" 5/8 - 1" 3/8	1.5
432	1" 3/8 - 1" 1/8	1
433	1" 3/8 - 1" 1/8	1.5
434	1" 1/8 - 7/8"	1
435	1" 1/8 - 7/8"	1.5
436	7/8" - 5/8"	1.5
437	7/8" - 5/8"	1
438	3/4" - 5/8"	1
439	3/4" - 5/8"	1.5
440	Ø su richiesta Ø upon request	

Example: punch for Ø 42 - 35 mm and max wall thickness 1 mm, reduces a tube with Ø 42 mm and wall thickness 1 mm, so as to be able to insert a tube with Ø 35.

PUNZONI PER COLLETTO PIATTO - PUNCHES FOR FLAT FLANGING



in mm		
Materiale: rame, ottone, alluminio, acciaio ricotto Material: copper, brass, aluminium, stainless steel		
Art.	Ø tubo - Ø tube	Spessore max - Max thickness
350	10	1.5
351	12	1.5
352	14	1.5
353	15	1.5
354	16	1.5
355	18	1.5
356	22	1.5
357	Ø su richiesta - Ø upon request	

in Pollici OD - in OD inches		
Materiale: rame, ottone, alluminio, acciaio ricotto Material: copper, brass, aluminium, stainless steel		
Art.	Ø tubo - Ø tube	Spessore max - Max thickness
450	3/8"	1.5
451	1/2"	1.5
452	5/8"	1.5
453	3/4"	1.5
454	7/8"	1.5
455	Ø su richiesta Ø upon request	

PUNZONI PER COLLETTO DOPPIO - PUNCHES FOR DOUBLE FLANGING



in mm		
Materiale: rame, ottone, alluminio, acciaio ricotto Material: copper, brass, aluminium, stainless steel		
Art.	Ø tubo - Ø tube	Spessore max - Max thickness
360	10	1.5
361	12	1.5
362	14	1.5
363	15	1.5
364	16	1.5
365	18	1.5
366	22	1.5
367	Ø su richiesta - Ø upon request	

in Pollici OD - in OD inches		
Materiale: rame, ottone, alluminio, acciaio ricotto Material: copper, brass, aluminium, stainless steel		
Art.	Ø tubo - Ø tube	Spessore max - Max thickness
460	3/8"	1
461	1/2"	1
462	5/8"	1
463	3/4"	1
464	7/8"	1
465	Ø su richiesta Ø upon request	

PUNZONI PER COLLETTO GAS - PUNCHES FOR GAS FLANGING



in mm		
Materiale: rame, ottone, alluminio, acciaio ricotto Material: copper, brass, aluminium, stainless steel		
Art.	Ø tubo - Ø tube	Spessore max - Max thickness
370	10	1
371	12	1
372	14	1
373	15	1
374	16	1
375	18	1
376	22	1
377	Ø su richiesta - Ø upon request	

in Pollici OD - in OD inches		
Materiale: rame, ottone, alluminio, acciaio ricotto Material: copper, brass, aluminium, stainless steel		
Art.	Ø tubo - Ø tube	Spessore max - Max thickness
470	3/8"	1.5
471	1/2"	1.5
472	5/8"	1.5
473	3/4"	1.5
474	7/8"	1.5
475	Ø su richiesta Ø upon request	

PUNZONI PER COLLETTO CONICO - PUNCHES FOR CONICAL FLANGING



in mm		
Materiale: rame, ottone, alluminio, acciaio ricotto Material: copper, brass, aluminium, stainless steel		
Art.	Angolo - Angle	Ø max tubo - Max Ø tube
380	37°	10 - 28
381	45°	10 - 28
382	Ø su richiesta - Ø upon request	

in Pollici OD - in OD inches		
Materiale: rame, ottone, alluminio, acciaio ricotto Material: copper, brass, aluminium, stainless steel		
Art.	Angolo - Angle	Ø max tubo - Max Ø tube
480	37°	1" 1/8 (28 mm)
481	45°	3/8" - 1" 1/8
482	Ø su richiesta - Ø upon request	

Pollici → Millimetri / Inch → Millimeter

0" +	=mm	1" +	=mm	2" +	=mm	3" +	=mm	4" +	=mm	5" +	=mm	6" +	=mm	Pollici	=mm
1/64	0.397	0	25.400	0	50.800	0	76.200	0	101.600	0	127.000	0	152.400	7	177.800
1/32	0.794	1/64	25.797	1/64	51.197	1/64	76.597	1/64	101.997	1/64	127.397	1/64	152.797	8	203.200
3/64	1.191	1/32	26.194	1/32	51.594	1/32	76.994	1/32	102.394	1/32	127.794	1/32	153.194	9	228.600
1/20	1.270	3/64	25.591	3/64	51.991	3/64	77.391	3/64	102.791	3/64	128.191	3/64	153.591	10	254.000
1/16	1.588	1/16	26.988	1/16	52.388	1/16	77.788	1/16	103.188	1/16	128.588	1/16	153.988	11	279.400
5/64	1.984	5/64	27.384	5/64	52.784	5/64	78.184	5/64	103.584	5/64	128.984	5/64	154.384	12	304.800
3/32	2.381	3/32	27.781	3/32	53.181	3/32	78.581	3/32	103.981	3/32	129.381	3/32	154.781	13	330.200
7/64	2.778	7/64	28.178	7/64	53.578	7/64	78.978	7/64	104.378	7/64	129.778	7/64	155.178	14	355.600
1/8	3.175	1/8	28.575	1/8	53.975	1/8	79.375	1/8	104.775	1/8	130.175	1/8	155.575	15	381.000
9/64	3.572	9/64	28.972	9/64	54.372	9/64	79.772	9/64	105.172	9/64	130.572	9/64	155.972	16	406.400
5/32	3.969	5/32	29.369	5/32	54.769	5/32	80.169	5/32	105.569	5/32	130.969	5/32	156.369	17	431.800
11/64	4.366	11/64	29.766	11/64	55.166	11/64	80.566	11/64	105.966	11/64	131.366	11/64	156.766	18	457.200
3/16	4.763	3/16	30.163	3/16	55.563	3/16	80.963	3/16	106.363	3/16	131.763	3/16	157.163	19	482.600
13/64	5.159	13/64	30.559	13/64	55.959	13/64	81.359	13/64	106.759	13/64	132.159	13/64	157.559	20	508.000
7/32	5.556	7/32	30.956	7/32	56.356	7/32	81.756	7/32	107.156	7/32	132.556	7/32	157.956	21	533.400
15/64	5.953	15/64	31.353	15/64	56.753	15/64	82.153	15/64	107.553	15/64	132.953	15/64	158.353	22	558.800
1/4	6.350	1/4	31.750	1/4	57.150	1/4	82.550	1/4	107.950	1/4	133.350	1/4	158.750	23	584.200
17/64	6.747	17/64	32.147	17/64	57.547	17/64	82.947	17/64	108.347	17/64	133.747	17/64	159.147	24	609.600
9/32	7.144	9/32	32.544	9/32	57.944	9/32	83.344	9/32	108.744	9/32	134.144	9/32	159.544	25	635.000
19/64	7.541	19/64	32.941	19/64	58.341	19/64	83.741	19/64	109.141	19/64	134.541	19/64	159.941	26	660.400
5/16	7.938	5/16	33.338	5/16	58.738	5/16	84.138	5/16	109.538	5/16	134.938	5/16	160.338	27	685.800
21/64	8.334	21/64	33.734	21/64	59.134	21/64	84.534	21/64	109.934	21/64	135.334	21/64	160.734	28	711.200
11/32	9.128	11/32	34.131	11/32	59.531	11/32	84.931	11/32	110.331	11/32	135.731	11/32	161.131	29	736.600
23/64	9.128	23/64	34.528	23/64	59.928	23/64	85.328	23/64	110.728	23/64	136.128	23/64	161.528	30	762.000
3/8	9.525	3/8	34.925	3/8	60.325	3/8	85.725	3/8	111.125	3/8	136.525	3/8	161.925	31	787.400
25/64	9.922	25/64	35.322	25/64	60.722	25/64	86.122	25/64	111.522	25/64	136.922	25/64	162.322	32	812.800
13/32	10.319	13/32	35.719	13/32	61.119	13/32	86.519	13/32	111.919	13/32	137.319	13/32	162.719	33	838.200
27/64	10.716	27/64	36.116	27/64	61.516	27/64	86.916	27/64	112.316	27/64	137.716	27/64	163.116	34	863.600
7/16	11.113	7/16	36.513	7/16	61.913	7/16	87.313	7/16	112.713	7/16	138.113	7/16	163.513	35	889.000
29/64	11.509	29/64	36.909	29/64	62.309	29/64	87.709	29/64	113.109	29/64	138.509	29/64	163.909	36	914.400
15/32	11.906	15/32	37.306	15/32	62.706	15/32	88.106	15/32	113.506	15/32	138.906	15/32	164.306	37	914.400
31/64	12.303	31/64	37.703	31/64	63.103	31/64	88.503	31/64	113.903	31/64	139.303	31/64	164.703	38	965.200
1/2	12.700	1/2	38.100	1/2	63.500	1/2	88.900	1/2	114.300	1/2	139.700	1/2	165.100	39	990.600
33/64	13.097	33/64	38.497	33/64	63.897	33/64	89.297	33/64	114.697	33/64	140.097	33/64	165.497	40	1016.000
17/32	13.494	17/32	38.894	17/32	63.897	17/32	89.694	17/32	115.094	17/32	140.494	17/32	165.894	41	1041.400
35/64	13.891	35/64	39.291	35/64	64.691	35/64	90.091	35/64	115.491	35/64	140.891	35/64	166.291	42	1066.800
9/16	14.288	9/16	39.688	9/16	65.088	9/16	90.488	9/16	115.888	9/16	141.288	35/64	166.688	43	1092.200
37/64	14.684	37/64	40.084	37/64	65.484	37/64	90.884	37/64	116.284	37/64	141.684	37/64	167.084	44	1117.600
19/32	15.081	19/32	40.481	19/32	65.881	19/32	91.281	19/32	116.681	19/32	142.081	19/32	167.481	45	1143.000
39/64	15.478	39/64	40.878	39/64	66.278	39/64	91.678	39/64	117.078	39/64	142.478	39/64	167.878	46	1168.400
5/8	15.875	5/8	41.275	5/8	66.675	5/8	92.075	5/8	117.475	5/8	142.875	5/8	168.275	47	1193.800
41/64	16.272	41/64	41.672	41/64	67.072	41/64	92.472	41/64	117.872	41/64	143.272	41/64	168.672	48	1219.200
21/32	16.669	21/32	42.069	21/32	67.469	21/32	92.869	21/32	118.269	21/32	143.669	21/32	169.069	49	1244.600
43/64	17.066	43/64	42.466	43/64	67.866	43/64	93.266	43/64	118.666	43/64	144.066	43/64	169.466	50	1270.000
11/16	17.463	11/16	42.863	11/16	68.263	11/16	93.266	11/16	119.063	11/16	144.463	11/16	169.863	51	1295.400
45/64	17.859	45/64	43.259	45/64	68.659	45/64	94.059	45/64	119.459	45/64	144.859	45/64	170.259	52	1320.800
23/32	18.256	23/32	43.656	23/32	69.059	23/32	94.456	23/32	119.856	23/32	145.256	23/32	170.656	53	1346.200
47/64	18.653	47/64	44.053	47/64	69.453	47/64	95.250	47/64	120.253	47/64	145.653	47/64	171.053	54	1371.600
3/4	19.050	3/4	44.450	3/4	69.850	3/4	95.647	3/4	120.650	3/4	146.050	3/4	171.450	55	1397.000
49/64	19.447	49/64	44.847	49/64	70.247	49/64	96.044	49/64	121.047	49/64	146.447	49/64	171.847	56	1422.400
25/32	19.844	25/32	45.244	25/32	70.644	25/32	96.441	25/32	121.444	25/32	146.844	25/32	172.244	57	1447.800
51/64	20.241	51/64	45.641	51/64	71.041	51/64	96.838	51/64	121.841	51/64	147.241	51/64	172.641	58	1473.200
13/16	20.638	13/16	46.038	13/16	71.438	13/16	97.234	13/16	122.238	13/16	147.638	13/16	173.038	59	1498.600
53/64	21.034	53/64	46.434	53/64	71.834	53/64	97.631	53/64	122.634	53/64	148.034	53/64	173.434	60	1524.000
27/32	21.431	27/32	46.831	27/32	72.231	27/32	98.028	27/32	123.031	27/32	148.431	27/32	173.831	60	1549.400
55/64	21.828	55/64	47.228	55/64	72.628	55/64	98.425	55/64	123.428	55/64	148.828	55/64	174.228	62	1574.800
7/8	22.225	7/8	47.625	7/8	73.025	7/8	98.822	7/8	123.825	7/8	149.225	7/8	174.625	63	1600.200
57/64	22.622	57/64	48.022	57/64	73.422	57/64	99.219	57/64	124.222	57/64	149.622	57/64	175.022	64	1625.600
29/32	23.019	29/32	48.419	29/32	73.819	29/32	99.219	29/32	124.619	29/32	150.019	29/32	175.419	65	1651.000
59/64	23.416	59/64	48.816	59/64	74.216	59/64	99.616	59/64	125.016	59/64	150.416	59/64	175.816	66	1676.400
15/16	23.813	15/16	49.213	15/16	74.613	15/16	100.013	15/16	125.413	15/16	150.813	15/16	176.213	67	1701.800
61/64	24.209	61/64	49.609	61/64	75.009	61/64	100.409	61/64	125.809	61/64	151.209	61/64	176.609	68	1727.200
31/32	24.606	31/32	50.006	31/32	75.406	31/32	100.806	31/32	126.206	31/32	151.606	31/32	177.006	69	1752.600
63/64	25.003	63/64	50.403	63/64	75.803	63/64	101.203	63/64	126.603	63/64	152.003	63/64	177.403	70	1778.000



Tabella dimensionale del tubo secondario ANSI B 36,10 E API / ANSI B 36.10 E API Secondary Pipe Dimension Table

Ø	Std	XS	XX2	sch. 10	sch. 20	sch. 30	sch. 40	sch. 60	sch. 80	sch. 100	sch. 120	sch. 140	
"	mm	mm	mm	mm	mm	mm	mm	mm	mm	mm	mm	mm	
1/8"	10.29	1.73	2.41	-	-	-	-	1.73	-	2.41	-	-	
1/4"	13.72	2.23	3.02	-	-	-	-	2.23	-	3.02	-	-	
3/8"	17.14	2.31	3.20	-	-	-	-	2.31	-	3.20	-	-	
1/2"	21.34	2.77	3.73	7.47	-	-	-	2.77	-	3.73	-	-	
3/4"	26.67	2.87	3.91	7.82	-	-	-	2.87	-	3.91	-	-	
1"	33.7	3.38	4.55	9.09	-	-	-	3.38	-	4.55	-	-	
2" 1/4	42.4	3.56	4.85	9.70	-	-	-	3.56	-	4.85	-	-	
1" 1/2	48.26	3.68	5.08	10.16	-	-	-	3.68	-	5.08	-	-	
2"	60.32	3.91	5.54	11.07	-	-	-	3.91	-	5.54	-	-	
2" 1/2	73.02	5.16	7.01	14.02	-	-	-	5.16	-	7.01	-	-	
3"	88.90	5.49	7.62	15.24	-	-	-	5.49	-	7.62	-	-	
3" 1/2	101.60	5.74	8.08	-	-	-	-	5.74	-	8.07	-	-	
4"	114.30	6.02	8.56	17.12	-	-	-	6.02	-	8.56	-	11.12	
5"	141.30	6.55	9.52	19.05	-	-	-	6.55	-	9.52	-	12.70	
6"	168.27	7.11	11.97	21.94	-	-	-	7.11	-	11.97	-	14.27	
8"	219.07	8.18	12.70	22.22	-	6.35	7.04	8.18	10.34	12.70	-	18.24	20.62
10"	273.05	9.27	12.70	-	-	6.35	7.80	9.27	12.70	15.06	15.06	21.41	25.40
12"	323.85	9.52	12.70	-	-	6.35	8.28	10.31	14.27	17.45	18.24	25.40	28.57
14"	355.60	9.52	12.70	-	6.35	7.92	9.52	11.12	15.06	19.05	21.41	27.76	31.75
16"	406.40	9.52	12.70	-	6.35	7.92	9.52	12.70	16.66	21.41	23.80	30.94	36.52
18"	457.20	9.52	12.70	-	6.35	7.92	11.12	14.27	19.05	23.80	26.19	34.92	39.67
20"	508.00	9.52	12.70	-	6.35	9.52	12.70	15.06	20.62	26.19	29.36	38.10	44.45
24"	609.60	9.52	12.70	-	6.35	9.52	14.27	17.45	24.59	30.94	32.54	46.02	52.37
30"	762.00	-	-	-	7.92	12.70	15.87	-	-	-	-	-	-

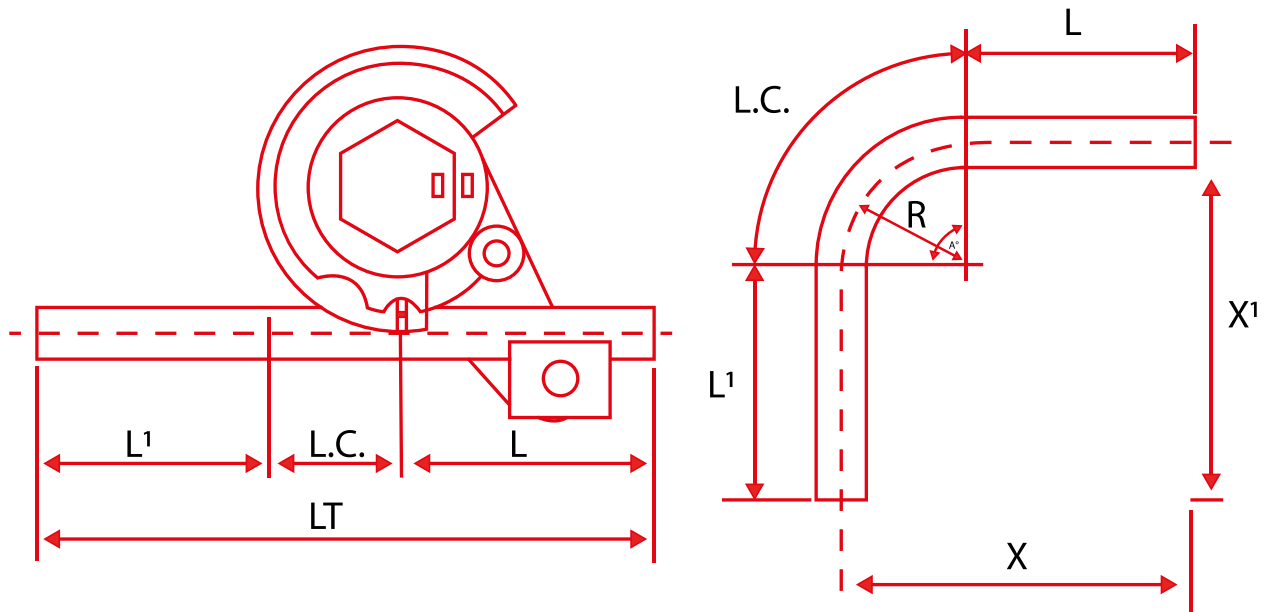

<p>R = Raggio di Curvatura*</p> <p>A° = Angolo di curvatura (gradi)</p> <p>L.C. = Lunghezza parte curvata = $\frac{2 \pi \times R}{360} \times A^\circ$</p> <p>X = Vedi Fig. 2</p> <p>X¹ = Vedi Fig. 2</p> <p>L = Lunghezza parte retta dx= X-R</p> <p>L¹ = Lunghezza parte retta sx= X-R</p> <p>L.T. = Lunghezza totale del tubo da curvare= L.C. + L¹ + L</p>	<p>Esempio di curvatura:</p> <p>R = 82</p> <p>A° = 90°</p> <p>L.C. = $\frac{6,28 \times 82}{360} \times 90^\circ = 128,8 \text{ mm}$</p> <p>X = 200mm</p> <p>X¹ = 200mm</p> <p>L = 200 - 82 = 118 mm</p> <p>L¹ = L200 - 82 = 118 mm</p> <p>L.T. = 128,8 + 118 + 118 = 364,8 mm</p>
--	---

<p>R = Radius of Curvature*</p> <p>A° = Angle of curvature (degrees)</p> <p>L.C. = Length of curved part = $\frac{2 \pi \times R}{360} \times A^\circ$</p> <p>X = See Fig. 2</p> <p>X¹ = See Fig. 2</p> <p>L = Straight part length dx= X-R</p> <p>L¹ = Straight part length sx= X-R</p> <p>L.T. = Total length of the tube to be bent = L.C. + L¹ + L</p>	<p>Example of curvature:</p> <p>R = 82</p> <p>A° = 90°</p> <p>L.C. = $\frac{6,28 \times 82}{360} \times 90^\circ = 128,8 \text{ mm}$</p> <p>X = 200mm</p> <p>X¹ = 200mm</p> <p>L = 200 - 82 = 118 mm</p> <p>L¹ = L200 - 82 = 118 mm</p> <p>L.T. = 128,8 + 118 + 118 = 364,8 mm</p>
---	---

PRIMA DI ORDINARE / BEFORE ORDERING

Compilare scheda dati di lavorazione (pag. 100).

Fill in the machining data sheet (page 100).

È fondamentale specificare i seguenti dati:

- di diametro o dimensione del profilo
- spessore
- materiale (AISI/DIN/JIS)
- raggio di curvatura

It is essential to specify the following data:

- profile diameter or size
- thickness
- material (AISI/DIN/JIS)
- radius of curvature

Alcuni campioni di materiale potrebbero essere richiesti per il collaudo degli utensili.

Some material samples may be required for tool testing.

Per le applicazioni speciali è necessario fornire un disegno tecnico del pezzo da eseguire.

For special applications it is necessary to provide a technical drawing of the workpiece.

L'azienda costruttrice non può essere ritenuta responsabile della errata fabbricazione degli utensili qualora i disegni non fossero allegati all'ordine.

The manufacturer cannot be held responsible for the incorrect manufacture of the tools unless the drawings were enclosed with the order.

DATA: _____

END USER INFORMATION

Company name:	
Contact person:	
Phone:	
Fax:	
E-mail:	
Known Ercolina through...	

PRODUCTION

Application	
Productivity	
Ovalizzazione:	
Tolerances	
Finishing	

BENDING SEQUENCE

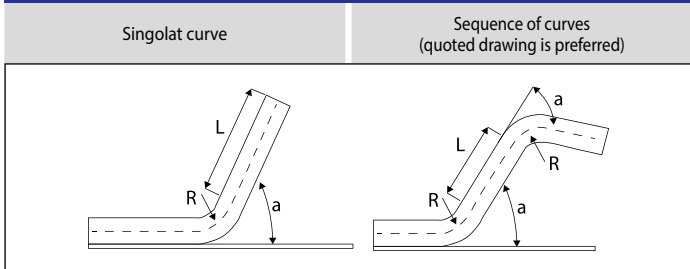

BENDING DIRECTION TABLE

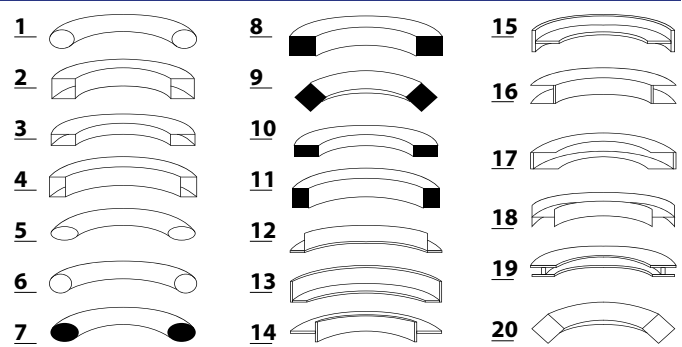

MACHINE

Purchased already	Art
Preferable Model	Art.
Voltage required	

NOTES

MATERIAL APPLICATION

Reference standard	Shape - Verso (see prospectus)	Dimensioni	Thickness	R Radius	Corner A	Straight section L

EXPANSION

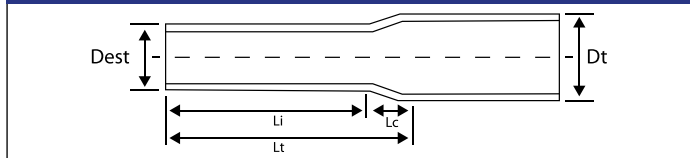

REDUCTION

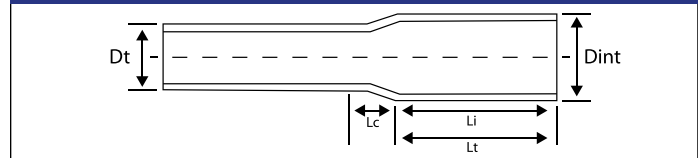

MATERIAL APPLICATION

Standards Reference	Tube Diameter (Dt)	Tube Wall Thickness	Application	Ø Outside Reduction (Dest)	Ø Inside Expansion (Dint)	Canical Length (Lc)	Tooling Penetration Length (LI)



Il nostro stabilimento produttivo è situato **a soli 5 minuti dal casello autostradale di Cassino.**

Vi invitiamo a venirci a visitare prenotando la vostra visita per vedere le nostre macchine. Troverete personale tecnico commerciale che vi illustrerà nel dettaglio le caratteristiche dei nostri prodotti tramite dimostrazione.

Siamo aperti dalle 9:00 alle 13:00 e dalle 14:00 alle 18:00.

Our production plant is located **just 5 minutes from the Cassino highway exit.**

We invite you to come and visit us booking your visit to see our machines. You will find technical and commercial staff who will explain in detail the characteristics of our products through a demonstration.

We are open from 9:00 to 13:00 and from 14:00 to 18:00.

INDIRIZZO / ADDRESS

CML INTERNATIONAL S.p.A.

Località Annunziata snc

03030 Piedimonte San Germano (FR)

Phone.: 0776 40281

E-mail: info@ercolina.it

Web site: www.ercolina.com

SEGUICI SU / FOLLOW US



SCOPRI LE MACCHINE ERCOLINA

DISCOVER ALL ERCOLINA MACHINES





**DAL 1973 SCRIVIAMO LA STORIA
DEL MADE IN ITALY NEL MONDO**

**SINCE 1973 MAKING HISTORY
MADE IN ITALY AROUND THE WORLD**

ERCOLINA

Località Annunziata snc
03030 Piedimonte S. Germano (FR)
(ITALY)
Tel. (+39) 0776 40281
Fax (+39) 0776 404801
info@ercolina.com
www.ercolina.it

PEDRAZZOLI

Sede Operativa Pedrazzoli
Viale Pecori Girarldi, 51
03061 - Bassano del Grappa (VI)
(ITALY)
Tel. (+39) 0424 509011
info@ercolina.pedrazzoli.it
www.pedrazzoli.it

OFFICIAL DEALER

FILIALI

CML DEUTSCHLAND

Remsweg 27,
73660 Urbach
(GERMANY)
Tel. (+49) 07181 872 66
Fax (+49) 07181 872 98
info@cml-deutschland.de
www.ercolina.de

CML USA

3100 Research Parkway
Davenport, Iowa 52806
(USA)
Tel. (+1) 563 391 77 00
Fax (+1) 563 391 77 10
info@ercolina-usa.com
www.ercolina-usa.com

CML ASIA

102, Building 201,
Bucheon Technopark, 397
Seokcheon-ro, Bucheon
(KOREA)
Tel. (+82) 32 624 1937
Fax (+82) 32 624 1940
info@ercolina.co.kr
www.ercolina.co.kr

CML RUSSIA

Varshavskoye shosse, House 125D
Building 1, Room 328
117587 Moscow
(RUSSIA)
Tel. (+7) 495 640 48 01
info@ercolina.ru
www.ercolina.ru



CML
INTERNATIONAL
SPA